

Arktis Laser Product Datasheet

LRD-0940 Collimated Diode Laser System



Series Specifications:

Nominal Wavelength	940 nm
Output Type	CW
Laser Source Type	Diode

Overview:

The LRD-0940 Series of Collimated Diode (Semiconductor) Lasers are ideal for applications requiring a wavelength of around 940 nm and a wide range of output power levels from 10 mW to 8 W with a high level of long-term output power stability and long operating lifetime at an aggressively competitive cost.

These lasers are commonly used for communications research as well as scientific applications involving spectral analysis, biology research, and a broad spectrum of other applications. The driver is available as a complete FDA-compliant system or as an O.E.M. component with significantly reduced dimensions.

Available with onboard and remote on/off control as well as a wide array of output power and stability levels, Laserglow products are currently being used by some of the world's top universities and other prominent research facilities.

Key Features:

- Air cooled - no need for water cooling or external chiller
- Lightweight, compact design
- Efficient Diode Laser technology runs on standard AC power (85 - 264 V, 47 - 63 Hz)
- >10,000 hours continuous maintenance-free operating life
- FDA CDRH Compliant Class IIIb / Class IV enclosure
- 48-hour replacement coverage available for an additional fee on specific models

Package Includes:

- Laser Head
- Driver/Power Supply
- Power Cable
- BNC Connector (LabSpec models only)
- Keys, Safety Interlock
- Hard-shell Carrying Case

Specifications:

This spec sheet has been generated specifically for part number D94-F, per your request, and data for the entire series is also displayed for your reference. The specs which are specific to D94-F have been highlighted below in **red + bold**.

Output Power (mW)	>100, >200, >250	>500, >1000	>2000, >5000, >6000	>7000
Output Power Stability (%RMS/4h)	<1, <3	<1, <3	<1, <3	<1, <3
Central Wavelength (nm)	940	940	940	940
Wavelength Tolerance (+/- nm)	5	5	5	5
Divergence (mrad, full angle)	<1	<3	<3	<3
Beam Dimensions (mm, 1/e ²)	3.5	5x8	5x8	5x8
Warm-up Time (minutes)	5	5	5	5
Approximate Peak Power (W)	499			
M ²		<20	<20	<20
Polarization Ratio		>50		
Beam Pointing Stability (mrad)	<0.05	<0.05	<0.05	<0.05
Operating Temperature Range (°C)	10 to 35	10 to 35	10 to 35	10 to 35
Max. Analog Modulation Freq. (Hz)	30000	30000	30000	30000
Max. TTL Modulation Freq. (Hz)	30000	30000	30000	30000
Modulation Input Signal	0-5 VDC	0-5 VDC	0-5 VDC	0-5 VDC
Max. Power Input Duty Cycle	100%	100%	100%	100%
Standard Warranty (months)	12	12	12	12
MTTF (operational hours)	10000	10000	10000	10000
Weight of Product or Laser Head (kg)	0.6	0.6	0.9	1.6
Beam Height from Base Plate (mm)	24.8	24.8	29	45
Dimensions of Product or Laser Head (mm)	140.7 (l) x 73 (w) x 46.2 (h)	140.7 (l) x 73 (w) x 46.2 (h)	155 (l) x 77 (w) x 60 (h)	211.5 (l) x 88 (w) x 74 (h)

CW: All specifications are based on performance at full output power and after the specified warmup period. Output characteristics may change if the laser is run at a different power level.

Q-Switched: Specifications are based on the laser pulsing at the specified design frequency. Output characteristics may change if the laser is run at a different frequency.

Power Supply Options:

These lasers are available with several different power supply options. The model that you have selected is highlighted below, and any other options are shown for easy reference.

	Power Supply Type:	FR	FT	FF
FDA-Compliant LabSpec 	Input Power	85v to 264v	85v to 264v	85v to 264v
	Power Supply Weight (kg)	1.5	2.6	2.6
	Dimensions (mm)	154 (l) x 155 (w) x 95 (h)	268 (l) x 145 (w) x 106 (h)	268 (l) x 145 (w) x 106 (h)

*Power supply may not be exactly as shown, see dimensional drawings on next 2 pages.

*Dimensions for fiber-integrated (I_) include laser head packaged inside.

Regulatory Classification:

The model you have selected (D94-F) requires the following safety label(s):



Dimensional Drawing - Laser Form Factor: F:

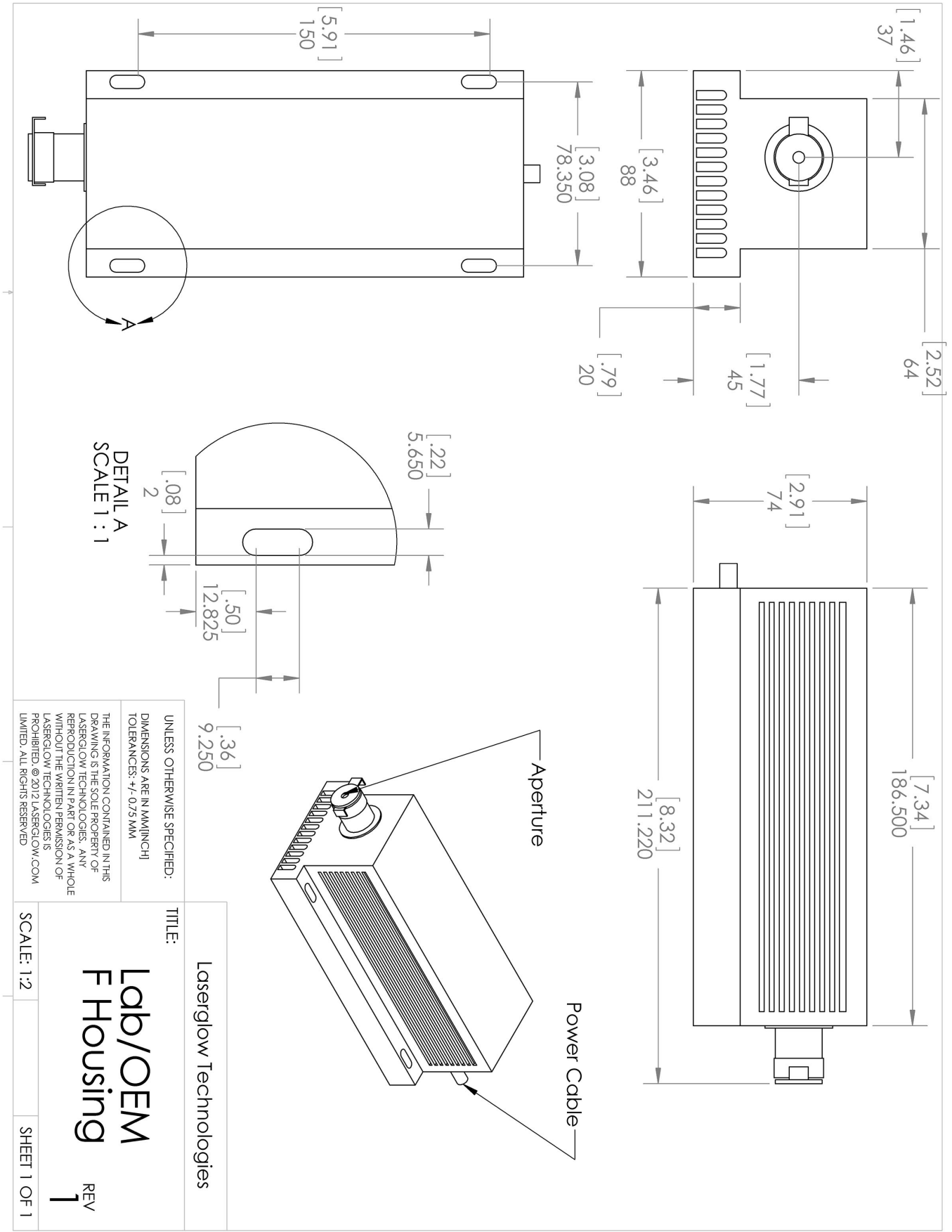

Dimensional Drawing - Power Supply Form Factor: FF:

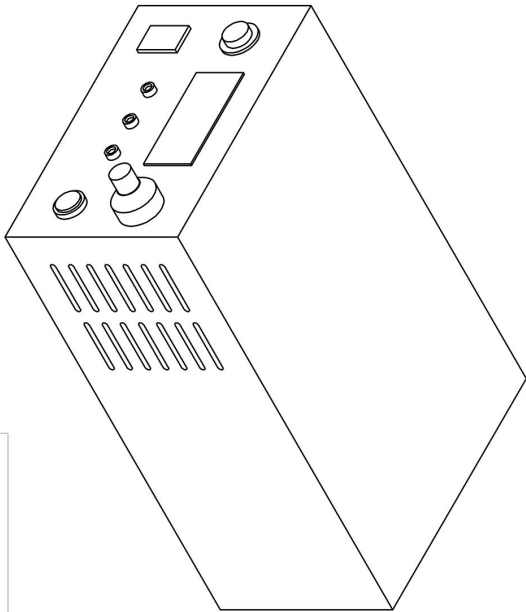
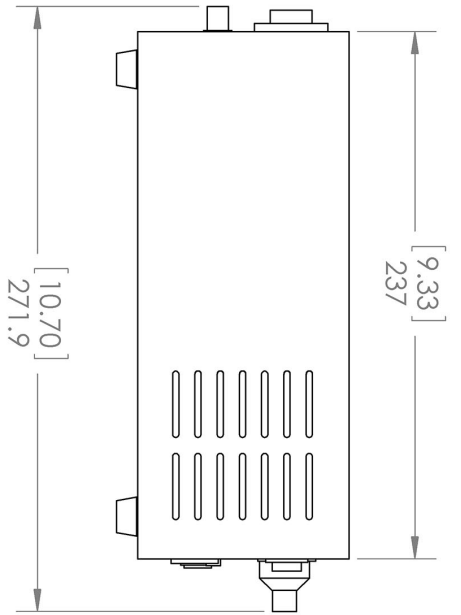
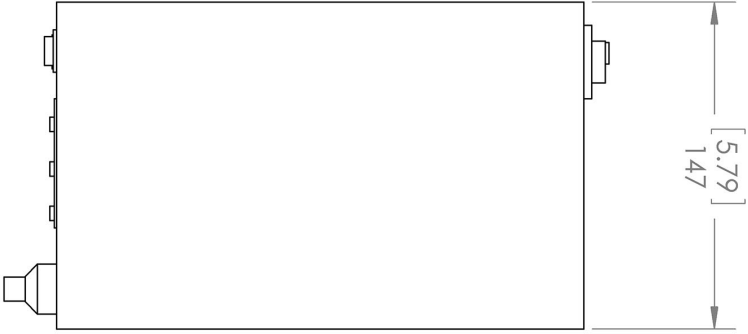
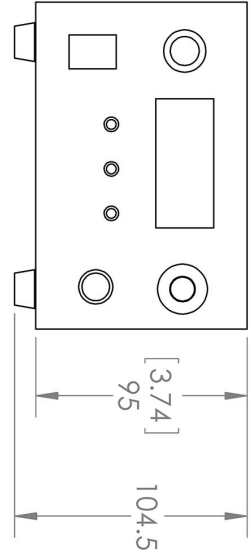







UNLESS OTHERWISE SPECIFIED:
 DIMENSIONS ARE IN MM(INCH)
 TOLERANCES: +/- 0.75 MM

THE INFORMATION CONTAINED IN THIS DRAWING IS THE SOLE PROPERTY OF LASERGLOW TECHNOLOGIES. ANY REPRODUCTION IN PART OR AS A WHOLE WITHOUT THE WRITTEN PERMISSION OF LASERGLOW TECHNOLOGIES IS PROHIBITED. © 2012 LASERGLOW.COM LIMITED. ALL RIGHTS RESERVED

TITLE: Power Supply FH/FF/FN	
SCALE: 1:3	SHEET 1 OF 1
Laserglow Technologies REV 1	

Accessories:

The most popular accessories for model D94-F are shown below. For additional details regarding these or other accessories please see our website or contact us directly.

Part Number	Description	
 AFF2002XX	Armored Fiber With FC/PC Connectors 200um Core Multimode 2m length Full Details: www.arktislaser.com/AFF	
 AFS2002XX	Armored Fiber With SMA 905 Connectors 200um Core Multimode 2 m length Full Details: www.arktislaser.com/AFS	
 AGFA647XX	LSG-1064-NF-7 Fit-Over Safety Goggles 1064nm Output: OD 7+ at 950-1070 nm CE Certified Full Details: www.arktislaser.com/AGF	
 ACFNIRHXA	FC/PC Fiber Coupler/Collimator for IR wavelengths (700 to 1000 nm) (installed and aligned) 11mm diameter input lens Full Details: www.arktislaser.com/ACF	
 ACSNIRHXA	SMA-905 Fiber Coupler/Collimator for IR wavelengths (700 to 1000nm) (installed and aligned) 11mm diameter input lens Full Details: www.arktislaser.com/ACS	
 ACALBMXXX	Carrying Case-102 Holds Lab/OEM M, R and S size, standard or LabSpec laser Full Details: www.arktislaser.com/ACA	Included With Laser

FOR MORE INFORMATION PLEASE CONTACT:

Arktis Laser
 112 Elizabeth St, Unit 5-331, Toronto, ON, Canada M5G 1P5
 Tel. 1-416-886-1178 Fax 1-647-874-7129
sales@arktislaser.com www.arktislaser.com

E&OE: Data included in this sheet may be subject to change without notice.

Please confirm critical specifications with our staff prior to ordering.