

## LLD-0905 Low-Noise Collimated Diode Laser System



### Series Specifications:

Nominal Wavelength	905 nm
Output Type	CW
Laser Source Type	Diode

### Overview:

The LLD-0905 Series of Low-Noise Collimated Diode Lasers are ideal for applications requiring less than 1% noise and output power levels from 10 mW to 200 mW. These 905 nm NIR lasers maintain a high level of long-term output power stability and long operating lifetime at an aggressively competitive cost.

These lasers are commonly used for fluorescence excitation, PIV, Raman Spectroscopy, and a broad spectrum of other applications. The driver is available as a complete FDA-compliant system or as an O.E.M. component with significantly reduced dimensions.

Laserglow products are currently being used by some of the World's top universities and other prominent research facilities.

### Key Features:

- 1% optical noise (20 Hz-20 MHz)
- Air cooled - no need for water cooling or external chiller
- Lightweight, compact design
- Efficient DPSS technology runs on standard AC power (85 - 264 V, 47 - 63 Hz)
- >10,000 hours continuous maintenance-free operating life
- FDA CDRH Compliant Class IIIb enclosure
- 48-hour replacement coverage available for an additional fee on specific models

### Package Includes:

- Laser Head
- Driver/Power Supply
- Power Cable
- BNC Connector (LabSpec models only)
- Keys, Safety Interlock
- Hard-shell Carrying Case

## Specifications:

This spec sheet has been generated specifically for part number J90-RL, per your request, and data for the entire series is also displayed for your reference. The specs which are specific to J90-RL have been highlighted below in **red + bold**.

Output Power (mW)	<b>&gt;10, &gt;50</b>	>10, >50, >100, >200
Output Power Stability (%RMS/4h)	<b>&lt;1, &lt;3, &lt;5</b>	<1, <3, <5
Central Wavelength (nm)	<b>905</b>	905
Wavelength Tolerance (+/- nm)	<b>5</b>	10
Divergence (mrad, full angle)	<b>&lt;1</b>	<2.5
Beam Dimensions (mm, 1/e <sup>2</sup> )	<b>3.5</b>	5x8
Warm-up Time (minutes)	<b>5</b>	10
Optical Noise Amplitude (%RMS @ 20 Hz - 20 MHz)	<b>&lt;1</b>	<1
M <sup>2</sup>		<20
Polarization Ratio		>50
Beam Pointing Stability (mrad)	<b>&lt;0.05</b>	<0.05
Operating Temperature Range (°C)	<b>10 to 35</b>	10 to 35
Max. Analog Modulation Freq. (Hz)	<b>30000</b>	30000
Max. TTL Modulation Freq. (Hz)	<b>30000</b>	30000
Modulation Input Signal	<b>0-5 VDC</b>	0-5 VDC
Max. Power Input Duty Cycle	<b>100%</b>	100%
Standard Warranty (months)	<b>12</b>	12
MTTF (operational hours)	<b>10000</b>	10000
Weight of Product or Laser Head (kg)	<b>0.6</b>	0.6
Beam Height from Base Plate (mm)	<b>24.8</b>	24.8
Dimensions of Product or Laser Head (mm)	<b>140.7 (l) x 73 (w) x 46.2 (h)</b>	140.7 (l) x 73 (w) x 46.2 (h)

CW: All specifications are based on performance at full output power and after the specified warmup period. Output characteristics may change if the laser is run at a different power level.

Q-Switched: Specifications are based on the laser pulsing at the specified design frequency. Output characteristics may change if the laser is run at a different frequency.

## Power Supply Options:

These lasers are available with several different power supply options. The model that you have selected is highlighted below, and any other options are shown for easy reference.

	Power Supply Type:	<b>FR</b>
FDA-Compliant LabSpec 	Input Power	<b>85v to 264v</b>
	Power Supply Weight (kg)	<b>1.5</b>
	Dimensions (mm)	<b>154 (l) x 155 (w) x 95 (h)</b>

\*Power supply may not be exactly as shown, see dimensional drawings on next 2 pages.

\*Dimensions for fiber-integrated (l\_) include laser head packaged inside.

## Regulatory Classification:

The model you have selected (J90-RL) requires the following safety label(s):



**Dimensional Drawing - Laser Form Factor: RL:**

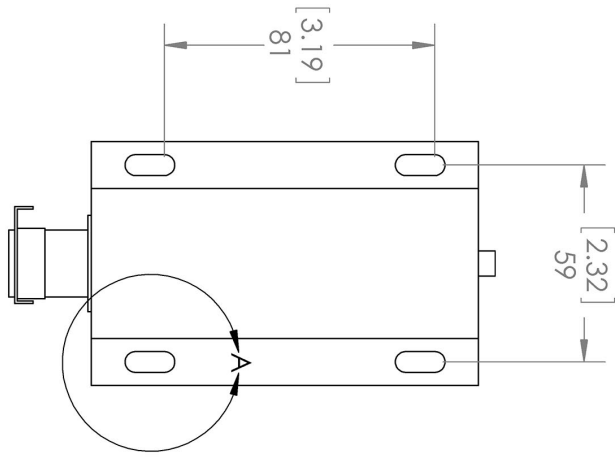

DETAIL A  
SCALE 1 : 1



UNLESS OTHERWISE SPECIFIED:  
DIMENSIONS ARE IN MM(INCH)  
TOLERANCES: +/- 0.75 MM

TITLE:		Laserglow Technologies
SCALE:		1:2
SHEET:		1 OF 1
<p><b>Lab/OEM</b> <b>M/R Housing</b> REV 1</p>		

THE INFORMATION CONTAINED IN THIS DRAWING IS THE SOLE PROPERTY OF LASERGLOW TECHNOLOGIES. ANY REPRODUCTION IN PART OR AS A WHOLE WITHOUT THE WRITTEN PERMISSION OF LASERGLOW TECHNOLOGIES IS PROHIBITED. © 2012 LASERGLOW.COM LIMITED. ALL RIGHTS RESERVED

**Dimensional Drawing - Power Supply Form Factor: FR:**

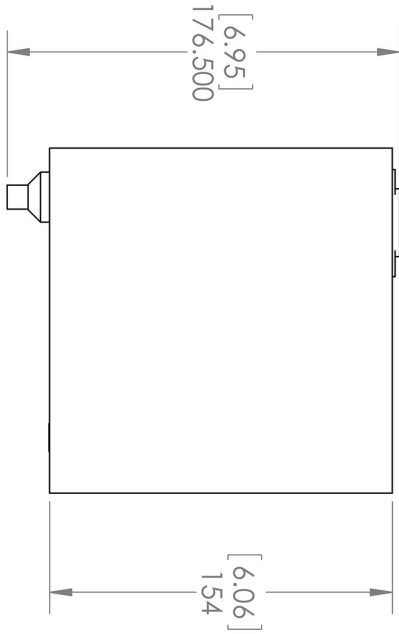

UNLESS OTHERWISE SPECIFIED:  
 DIMENSIONS ARE IN MM(INCH)  
 TOLERANCES: +/- 0.75 MM

THE INFORMATION CONTAINED IN THIS DRAWING IS THE SOLE PROPERTY OF LASERGLOW TECHNOLOGIES. ANY REPRODUCTION IN PART OR AS A WHOLE WITHOUT THE WRITTEN PERMISSION OF LASERGLOW TECHNOLOGIES IS PROHIBITED. © 2012 LASERGLOW.COM LIMITED. ALL RIGHTS RESERVED

**Laserglow Technologies**

TITLE:

**Power Supply  
 FM/FR**







REV  
**1**

SCALE: 1:3

SHEET 1 OF 1

## Accessories:

The most popular accessories for model J90-RL are shown below. For additional details regarding these or other accessories please see our website or contact us directly.

Part Number	Description	
 ACALBMXXX	Carrying Case-102 Holds Lab/OEM M, R and S size, standard or LabSpec laser Full Details: <a href="http://www.arktislaser.com/ACA">www.arktislaser.com/ACA</a>	Included With Laser
 ACSNIRHXA	SMA-905 Fiber Coupler/Collimator for IR wavelengths (700 to 1000nm) (installed and aligned) 11mm diameter input lens Full Details: <a href="http://www.arktislaser.com/ACS">www.arktislaser.com/ACS</a>	
 ACFNIRHXA	FC/PC Fiber Coupler/Collimator for IR wavelengths (700 to 1000 nm) (installed and aligned) 11mm diameter input lens Full Details: <a href="http://www.arktislaser.com/ACF">www.arktislaser.com/ACF</a>	
 AFS2002XX	Armored Fiber With SMA 905 Connectors 200um Core Multimode 2 m length Full Details: <a href="http://www.arktislaser.com/AFS">www.arktislaser.com/AFS</a>	
 AFF2002XX	Armored Fiber With FC/PC Connectors 200um Core Multimode 2m length Full Details: <a href="http://www.arktislaser.com/AFF">www.arktislaser.com/AFF</a>	
 AGFKTP59X	LSG-KTP-NF-6 Fit-Over Safety Goggles 532/808/1064nm Output: OD 6+ at 190-534/740-1064 nm CE Certified Full Details: <a href="http://www.arktislaser.com/AGF">www.arktislaser.com/AGF</a>	

## FOR MORE INFORMATION PLEASE CONTACT:

Arktis Laser  
112 Elizabeth St, Unit 5-331, Toronto, ON, Canada M5G 1P5  
Tel. 1-416-886-1178 Fax 1-647-874-7129  
[sales@arktislaser.com](mailto:sales@arktislaser.com) [www.arktislaser.com](http://www.arktislaser.com)

E&OE: Data included in this sheet may be subject to change without notice.

Please confirm critical specifications with our staff prior to ordering.