

## Arktis Laser Product Datasheet

### LMS-RGB1 Combined Triple-Wavelength Laser System

#### Series Specifications:

Nominal Wavelength	473 nm, 532 nm, 671 nm
Output Type	CW
Laser Source Type	DPSS

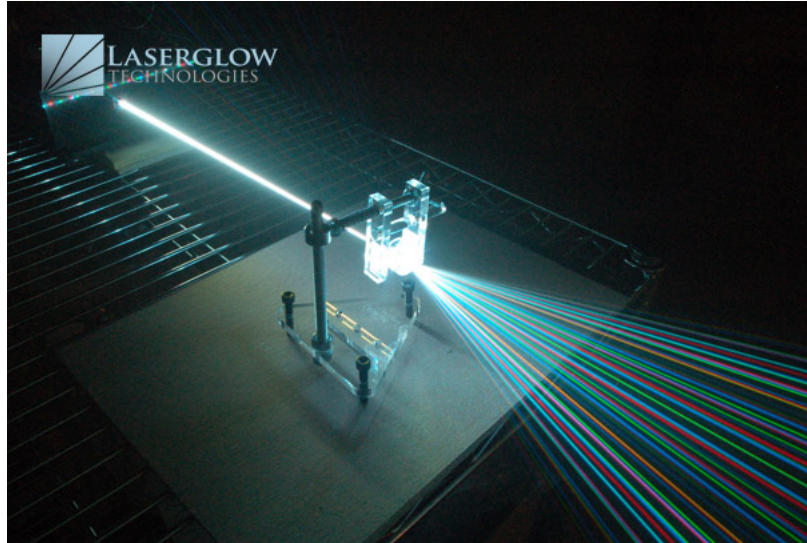

#### Overview:

The LMS-RGB1 Series of Combined-wavelength Diode-Pumped Solid-State (DPSS) Lasers are ideal for applications requiring red, green, and blue wavelengths to be emitted from a single laser module- simultaneously or individually. These RGB laser systems are available in up to 500 mW combined output with a high level of long-term output power stability and long operating lifetime at an aggressively competitive cost.

These lasers are commonly used for laser light shows (entertainment) as well as a variety of scientific applications including, PIV, Raman Spectroscopy, and a broad spectrum of other applications. The driver is available as a complete FDA-compliant system or as an O.E.M. component with significantly reduced dimensions.

Available with TTL and Analog modulation, and in a wide array of output power and stability levels, Laserglow products are currently being used by some of the World's top universities and other prominent research facilities.

#### Key Features:

- Air cooled - no need for water cooling or external chiller
- Lightweight, compact design
- Efficient DPSS technology runs on standard AC power (85 - 264 V, 47 - 63 Hz)
- >10,000 hours continuous maintenance-free operating life
- TTL and Analog modulation (input via BNC connector) *lab-spec models only*
- Adjustable output power via lockable dial) *lab-spec models only*
- LED display showing LD current, laser cavity temperature *lab-spec models only*
- FDA CDRH Compliant Class IIIb / Class IV enclosure
- 48-hour replacement coverage available for an additional fee on specific models

#### Package Includes:

- Laser Head
- Driver/Power Supply
- Power Cable
- BNC Connector (LabSpec models only)
- Keys, Safety Interlock
- Hard-shell Carrying Case

**Specifications:**

This spec sheet has been generated specifically for part number M31-2, per your request. Each column represents the specifications of the individual component lasers that make up the multi-wavelength system.

Component Laser Wavelength (nm)	473	532	671
Output Power (mW)	>100	>100	>100
Output Power Stability (%RMS/4h)	<3	<3	<3
Divergence (mrad, full angle)	<1.5	<1.5	<1.5
Beam Dimensions (mm, 1/e <sup>2</sup> )	2	2	1.2
M <sup>2</sup>	<1.2	<1.2	<1.2
Max. Analog Modulation Freq. (Hz)	30000	30000	30000
Max. TTL Modulation Freq. (Hz)	30000	30000	30000
Modulation Input Signal	0-5 VDC	0-5 VDC	0-5 VDC
Total Power Consumption (W)	25	32	23
Max. Power Input Duty Cycle	100%	100%	100%
Standard Warranty (months)	12	12	12
MTTF (operational hours)	10000	10000	10000

CW: All specifications are based on performance at full output power and after the specified warmup period. Output characteristics may change if the laser is run at a different power level.

Q-Switched: Specifications are based on the laser pulsing at the specified design frequency. Output characteristics may change if the laser is run at a different frequency.

## Power Supply Options:

These lasers are available with several different power supply options. The model that you have selected is highlighted below, and any other options are shown for easy reference.

	Power Supply Type:	<b>FM</b>
FDA-Compliant LabSpec 	Input Power	<b>85v to 264v</b>
	Power Supply Weight (kg)	<b>1.5</b>
	Dimensions (mm)	<b>154 (l) x 155 (w) x 95 (h)</b>

Multi-wavelength lasers include a separate power supply for each wavelength. In some cases the power supply for each wavelength may be slightly different in size. If the dimensions of the power supply are a concern for you please inquire with us before placing your order.

\*Power supply may not be exactly as shown, see dimensional drawings on next 2 pages.

\*Dimensions for fiber-integrated (I\_) include laser head packaged inside.

## Regulatory Classification:

The model you have selected (M31-2) requires the following safety label(s):



**Dimensional Drawing - Laser Form Factor: 2:**

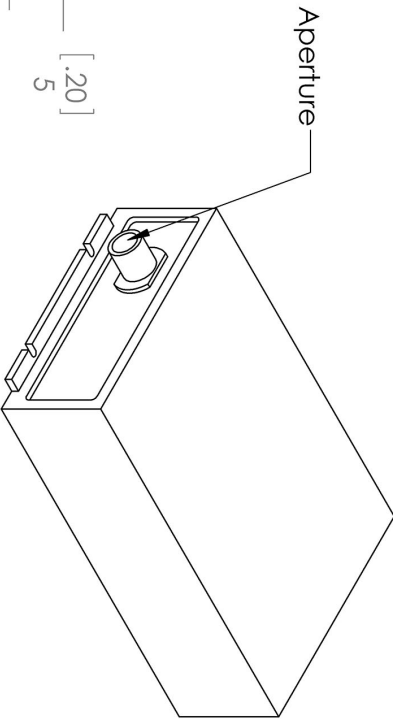
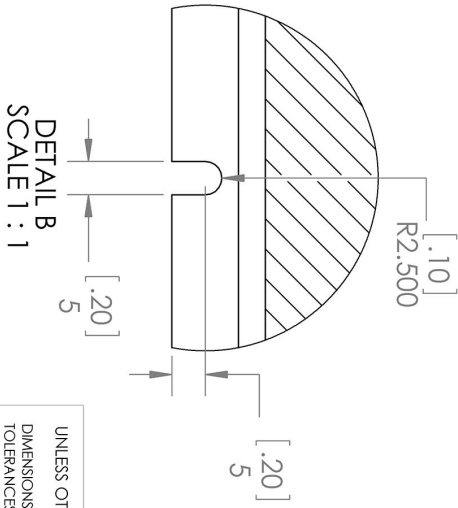
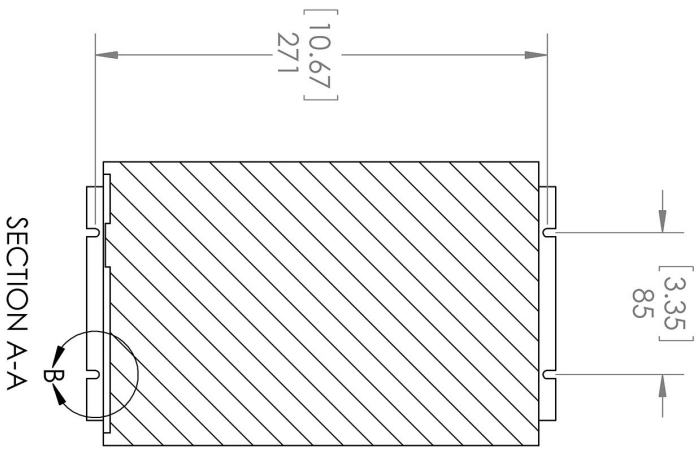
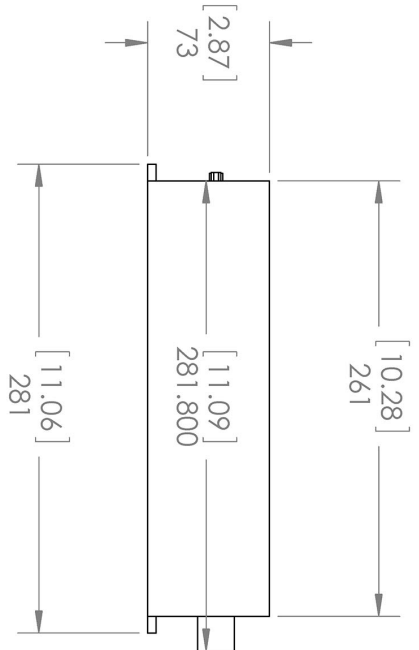
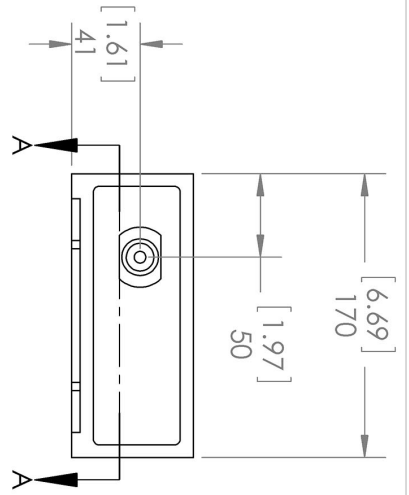

UNLESS OTHERWISE SPECIFIED: DIMENSIONS ARE IN MILLIMETER TOLERANCES: +/- 0.075 MM		TITLE: <b>Laserglow Technologies</b> <b>Lab/OEM</b> <b>2 Housing</b> REV <b>1</b>
THE INFORMATION CONTAINED IN THIS DRAWING IS THE SOLE PROPERTY OF LASERGLOW TECHNOLOGIES. ANY REPRODUCTION IN PART OR AS A WHOLE WITHOUT THE WRITTEN PERMISSION OF LASERGLOW TECHNOLOGIES IS PROHIBITED. © 2012 LASERGLOW.COM LIMITED. ALL RIGHTS RESERVED		SCALE: 1:4 SHEET 1 OF 1

**Dimensional Drawing - Power Supply Form Factor: FM:**

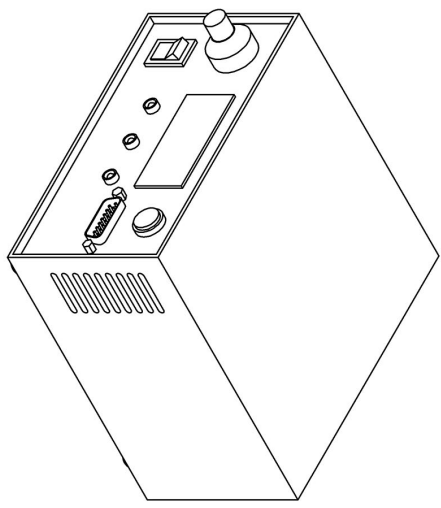
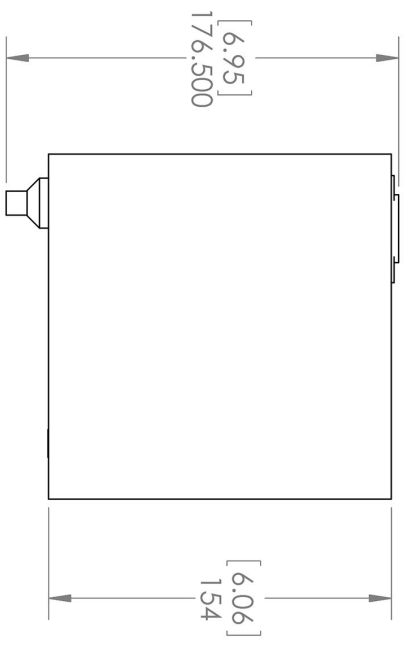
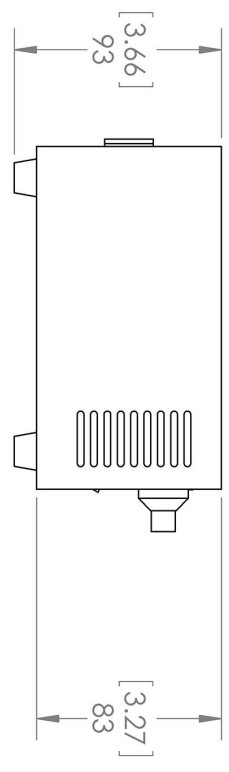
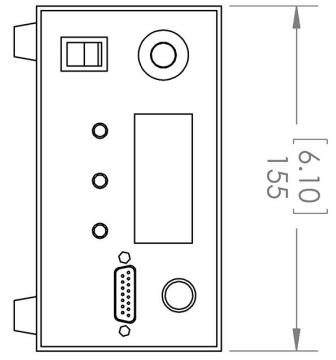

UNLESS OTHERWISE SPECIFIED:  
 DIMENSIONS ARE IN MM(INCH)  
 TOLERANCES: +/- 0.75 MM

THE INFORMATION CONTAINED IN THIS DRAWING IS THE SOLE PROPERTY OF LASERGLOW TECHNOLOGIES. ANY REPRODUCTION IN PART OR AS A WHOLE WITHOUT THE WRITTEN PERMISSION OF LASERGLOW TECHNOLOGIES IS PROHIBITED. © 2012 LASERGLOW.COM LIMITED. ALL RIGHTS RESERVED

**Laserglow Technologies**

TITLE:

**Power Supply  
 FM/FR**





REV  
**1**

SCALE: 1:3

SHEET 1 OF 1

## Accessories:

The most popular accessories for model M31-2 are shown below. For additional details regarding these or other accessories please see our website or contact us directly.

Part Number	Description	
 ACS-VISHXA	SMA-905 Fiber Coupler/Collimator for visible spectrum wavelengths (400 to 700 nm) (installed and aligned) 11mm diameter input lens Full Details: <a href="http://www.arktislaser.com/ACS">www.arktislaser.com/ACS</a>	
 ACF-VISHXA	FC/PC Fiber Coupler/Collimator for visible spectrum wavelengths (400 to 700 nm) (installed and aligned) 11mm diameter input lens Full Details: <a href="http://www.arktislaser.com/ACF">www.arktislaser.com/ACF</a>	
 ACALB237X	Carrying Case-107 Holds Lab/OEM 2/3 wavelength Labspec laser Full Details: <a href="http://www.arktislaser.com/ACA">www.arktislaser.com/ACA</a>	Included With Laser
 AFS2002XX	Armored Fiber With SMA 905 Connectors 200um Core Multimode 2 m length Full Details: <a href="http://www.arktislaser.com/AFS">www.arktislaser.com/AFS</a>	
 AFF2002XX	Armored Fiber With FC/PC Connectors 200um Core Multimode 2m length Full Details: <a href="http://www.arktislaser.com/AFF">www.arktislaser.com/AFF</a>	

## FOR MORE INFORMATION PLEASE CONTACT:

Arktis Laser  
112 Elizabeth St, Unit 5-331, Toronto, ON, Canada M5G 1P5  
Tel. 1-416-886-1178 Fax 1-647-874-7129  
[sales@arktislaser.com](mailto:sales@arktislaser.com) [www.arktislaser.com](http://www.arktislaser.com)

E&OE: Data included in this sheet may be subject to change without notice.

Please confirm critical specifications with our staff prior to ordering.