

Arktis Laser Product Datasheet

LPS-1573 AOM Q-Switched DPSS Laser System



Series Specifications:

Nominal Wavelength	1573 nm
Output Type	Q-Switched
Laser Source Type	DPSS

Overview:

The LPS-1573 Series of Diode-Pumped Solid-State (DPSS) AOM Q-Switched Lasers are ideal for applications requiring the highest available peak power and/or single pulse energy at 1573 nm. The embedded AOM gives the user direct control over the output pulses, enabling a specified frequency or even a single pulse to be emitted.

These lasers are commonly used for materials processing, marking, Raman Spectroscopy, biological experimentation and a broad spectrum of other applications. The driver is available as a complete FDA-compliant system or as an O.E.M. component with significantly reduced dimensions.

Key Features:

- AOM q-switch allows for active control of pulses
- Air cooled - no need for water cooling or external chiller
- Lightweight, compact design
- Efficient DPSS technology runs on standard AC power (85 - 264 V, 47 - 63 Hz)
- >10,000 hours continuous maintenance-free operating life
- FDA CDRH Compliant Class IV enclosure
- 48-hour replacement coverage available for an additional fee on specific models

Package Includes:

- Laser Head
- Driver/Power Supply
- Power Cable
- BNC Connector (LabSpec models only)
- Keys, Safety Interlock
- Hard-shell Carrying Case

Specifications:

This spec sheet has been generated specifically for part number PF7-W, per your request, and data for the entire series is also displayed for your reference. The specs which are specific to PF7-W have been highlighted below in **red + bold**.

Output Power (mW)	>100, >200, >300, >500, >800, >1000
Single Pulse Energy (µJ)	3, 6, 10, 15, 25, 35
Optimal Pulse Frequency (Hz)	30000
Output Power Stability (%RMS/4h)	<1, <3, <5
Wavelength Tolerance (+/- nm)	1
Divergence (mrad, full angle)	<2
Beam Dimensions (mm, 1/e ²)	4
Warm-up Time (minutes)	10
Avg. Pulse Duration (ns)	10
Approx. Timing Jitter (+/- ns)	10
Approx. Trigger-Pulse Latency (µs)	200
Operating Temperature Range (°C)	15 to 35
Max. TTL Modulation Freq. (Hz)	200,000
Modulation Input Signal	0-5 VDC
Max. Power Input Duty Cycle	100%
Standard Warranty (months)	12
MTTF (operational hours)	10000
Weight of Product or Laser Head (kg)	6.1
Beam Height from Base Plate (mm)	93.5
Dimensions of Product or Laser Head (mm)	346 (l) x 140 (w) x 125 (h)

CW: All specifications are based on performance at full output power and after the specified warmup period. Output characteristics may change if the laser is run at a different power level.

Q-Switched: Specifications are based on the laser pulsing at the specified design frequency. Output characteristics may change if the laser is run at a different frequency.

Power Supply Options:

These lasers are available with several different power supply options. The model that you have selected is highlighted below, and any other options are shown for easy reference.

	Power Supply Type:	AW
 FDA-Compliant AOM Driver	Input Power	85v to 264v
	Power Supply Weight (kg)	6.88
	Dimensions (mm)	334 (l) x 300 (w) x 123 (h)

*Power supply may not be exactly as shown, see dimensional drawings on next 2 pages.

*Dimensions for fiber-integrated (I_) include laser head packaged inside.

Regulatory Classification:

The model you have selected (PF7-W) requires the following safety label(s):

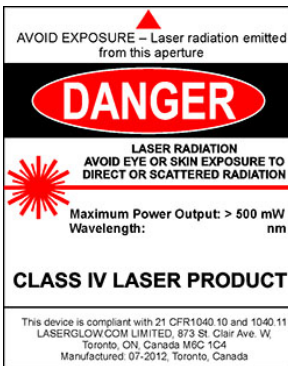

Dimensional Drawing - Laser Form Factor: W:

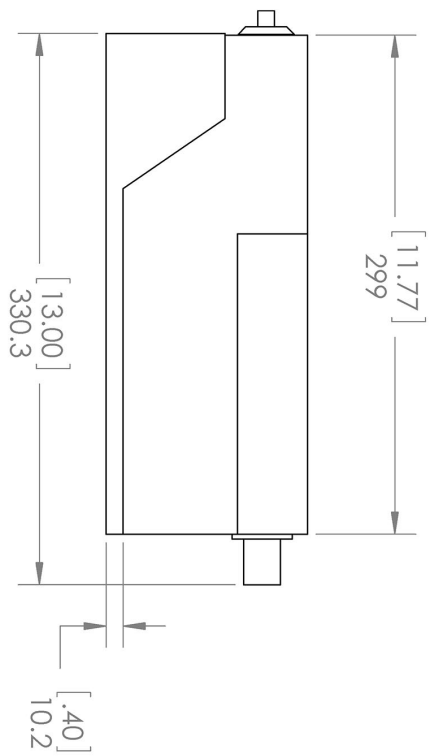

DETAIL A
SCALE 1 : 1.5

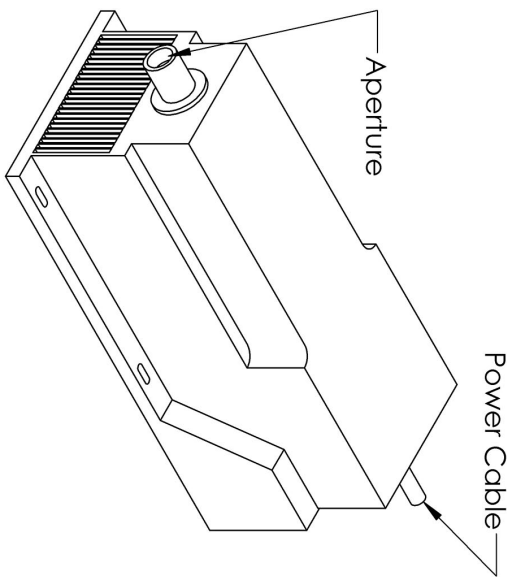

UNLESS OTHERWISE SPECIFIED:
DIMENSIONS ARE IN MM(INCH)
TOLERANCES: +/- 0.75 MM

THE INFORMATION CONTAINED IN THIS DRAWING IS THE SOLE PROPERTY OF LASERGLOW TECHNOLOGIES. ANY REPRODUCTION IN PART OR AS A WHOLE WITHOUT THE WRITTEN PERMISSION OF LASERGLOW TECHNOLOGIES IS PROHIBITED. © 2012 LASERGLOW.COM LIMITED. ALL RIGHTS RESERVED

TITLE:
Laserglow Technologies

Lab/OEM
W Housing

REV
1

SCALE: 1:4

SHEET 1 OF 1

Dimensional Drawing - Power Supply Form Factor: AW:

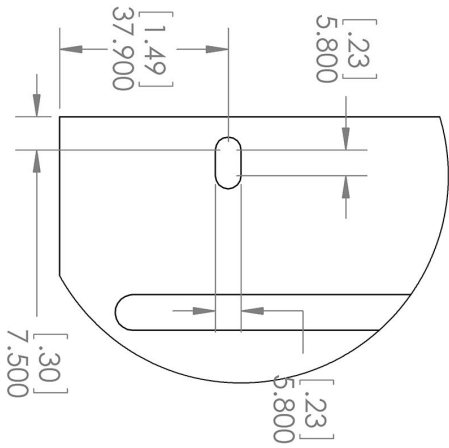
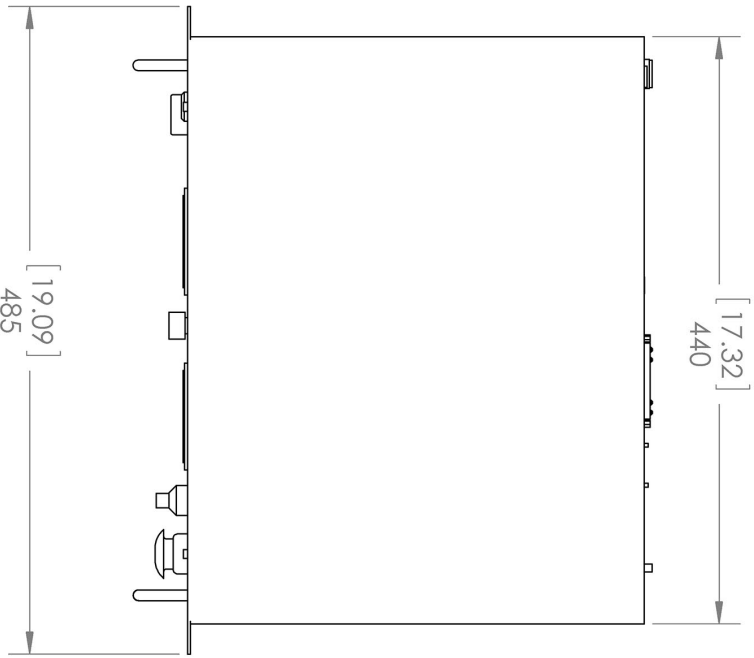
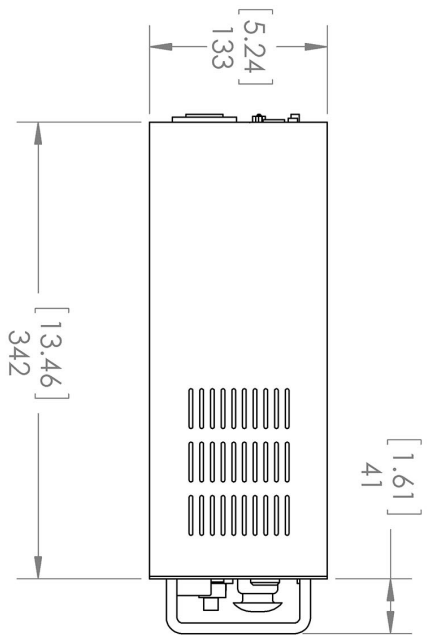
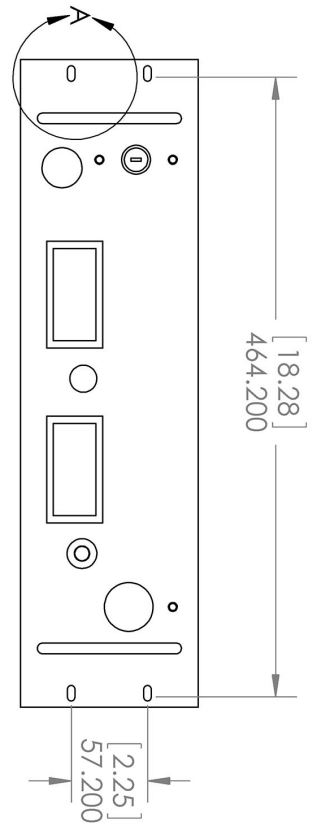



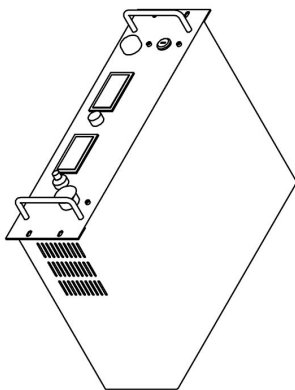



DETAIL A
SCALE 1 : 1.5



<p>UNLESS OTHERWISE SPECIFIED: DIMENSIONS ARE IN MILLIMETER TOLERANCES: +/- 0.75 MM</p>		<p>TITLE: Laserglow Technologies</p>	
<p>THE INFORMATION CONTAINED IN THIS DRAWING IS THE SOLE PROPERTY OF LASERGLOW TECHNOLOGIES. ANY REPRODUCTION IN PART OR AS A WHOLE WITHOUT THE WRITTEN PERMISSION OF LASERGLOW TECHNOLOGIES IS PROHIBITED. © 2012 LASERGLOW.COM LIMITED. ALL RIGHTS RESERVED</p>		<p>AW Supply</p>	
SCALE: 1:5		REV 1	SHEET 1 OF 1

Accessories:

The most popular accessories for model PF7-W are shown below. For additional details regarding these or other accessories please see our website or contact us directly.

Part Number	Description	
 ACFLIRHXA	FC/PC Fiber Coupler/Collimator for IR wavelengths (1300 to 1600 nm) (installed and aligned) 11 mm diameter input lens Full Details: www.arktislaser.com/ACF	
 ACSLIRHXA	SMA-905 Fiber Coupler/Collimator for IR wavelengths (1300 to 1600 nm) (installed and aligned) 11 mm diameter input lens Full Details: www.arktislaser.com/ACS	
 ACALBNWXX	Carrying Case-104 Holds Lab/OEM N or W size Standard/Labspec laser Full Details: www.arktislaser.com/ACA	Included With Laser
 AFS2002XX	Armored Fiber With SMA 905 Connectors 200um Core Multimode 2 m length Full Details: www.arktislaser.com/AFS	
 AFF2002XX	Armored Fiber With FC/PC Connectors 200um Core Multimode 2m length Full Details: www.arktislaser.com/AFF	
 AGFMIR4XX	LSG-MIR-NF-4 Fit-Over Safety Goggles Mid-IR Range Output: OD 4+ at 945-10600 nm CE Certified Full Details: www.arktislaser.com/AGF	

FOR MORE INFORMATION PLEASE CONTACT:

Arktis Laser
112 Elizabeth St, Unit 5-331, Toronto, ON, Canada M5G 1P5
Tel. 1-416-886-1178 Fax 1-647-874-7129
sales@arktislaser.com www.arktislaser.com

E&OE: Data included in this sheet may be subject to change without notice.

Please confirm critical specifications with our staff prior to ordering.