

LQS-0532 Passively Q-Switched Laser System



Series Specifications:

Nominal Wavelength	532 nm
Output Type	Q-Switched
Laser Source Type	DPSS

Overview:

The LQS-0532 Series of Diode-Pumped Solid-State (DPSS) Q-Switched Lasers are ideal for applications requiring a very high peak power or short pulse duration at 532 nm.

These lasers are commonly used for fluorescence excitation, Raman spectroscopy, material processing, and a broad range of other applications. The driver is available as a plug-and-play benchtop system or an O.E.M. component designed for system integration.

Key Features:

- Pulse energy of 1 μ J - 30 μ J
- Pulse repetition rate of 1 Hz - 4 kHz
- Pulse duration of 10 ns
- Air cooled
- Runs on standard AC power (85 - 264 V, 47 - 63 Hz)
- 10,000 hour maintenance-free operating life (Expected)
- FDA/CDRH compliant Class IV enclosure

Package Includes:

- Laser Head
- Driver/Power Supply
- Power Cable
- BNC Connector (LabSpec models only)
- Keys, Safety Interlock
- Hard-shell Carrying Case

Specifications:

This spec sheet has been generated specifically for part number Q53-H, per your request, and data for the entire series is also displayed for your reference. The specs which are specific to Q53-H have been highlighted below in **red + bold**.

Output Power (mW)	>12	>20, >40, >80, >120
Single Pulse Energy (µJ)	3	5, 10, 20, 30
Optimal Pulse Frequency (Hz)	4000	4000
Output Power Stability (%RMS/4h)	<1, <3, <5	<1, <3, <5, <10
Central Wavelength (nm)	531.65	531.65
Wavelength Tolerance (+/- nm)	1	1
Divergence (mrad, full angle)	<1.5	<1.5
Beam Dimensions (mm, 1/e ²)	1.2	1
Warm-up Time (minutes)	10	10
Avg. Pulse Duration (ns)	10	10
Approximate Peak Power (W)	100	300, 500, 800, 1000
Optical Noise Amplitude (%RMS @ 20 Hz - 20 MHz)	<20	<20
Spectral Linewidth (nm)	<0.2	<0.12
M ²	<1.2	<1.5
Polarization Ratio		>100
Beam Pointing Stability (mrad)	<0.05	<0.05
Operating Temperature Range (°C)	10 to 35	10 to 35
Max. TTL Modulation Freq. (Hz)	20000	20000
Minimum Pulsing Frequency (Hz)	1	1
Modulation Input Signal	0-5 VDC	0-5 VDC
Total Power Consumption (W)	28	90
Max. Power Input Duty Cycle	100%	100%
Standard Warranty (months)	12	12
MTTF (operational hours)	10000	10000
Weight of Product or Laser Head (kg)	0.6	0.9

CW: All specifications are based on performance at full output power and after the specified warmup period. Output characteristics may change if the laser is run at a different power level.

Q-Switched: Specifications are based on the laser pulsing at the specified design frequency. Output characteristics may change if the laser is run at a

different frequency.

Specifications Page 2:

Laser Form Factor		
Beam Height from Base Plate (mm)	24.8	29
Dimensions of Product or Laser Head (mm)	140.8 (l) x 73 (w) x 46.2 (h)	155 (l) x 77 (w) x 60 (h)

CW: All specifications are based on performance at full output power and after the specified warmup period. Output characteristics may change if the laser is run at a different power level.

Q-Switched: Specifications are based on the laser pulsing at the specified design frequency. Output characteristics may change if the laser is run at a different frequency.

Power Supply Options:

These lasers are available with several different power supply options. The model that you have selected is highlighted below, and any other options are shown for easy reference.

	Power Supply Type:	SM	SH
 FDA-Compliant Standard	Input Power	85v to 264v	85v to 264v
	Power Supply Weight (kg)	1.2	2.3
	Dimensions (mm)	133 (l) x 130 (w) x 65 (h)	238 (l) x 146 (w) x 102 (h)

*Power supply may not be exactly as shown, see dimensional drawings on next 2 pages.

*Dimensions for fiber-integrated (I_) include laser head packaged inside.

Regulatory Classification:

The model you have selected (Q53-H) requires the following safety label(s):

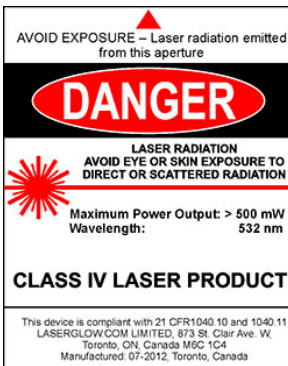

Dimensional Drawing - Laser Form Factor: H:

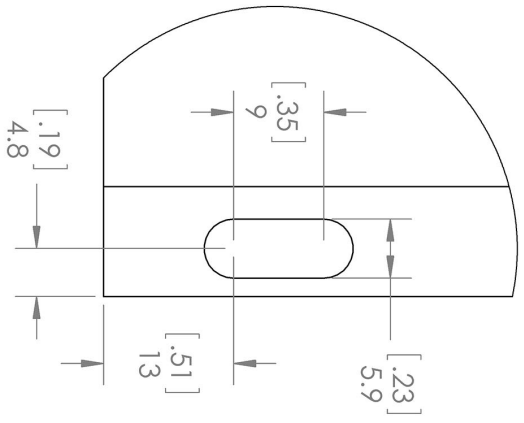
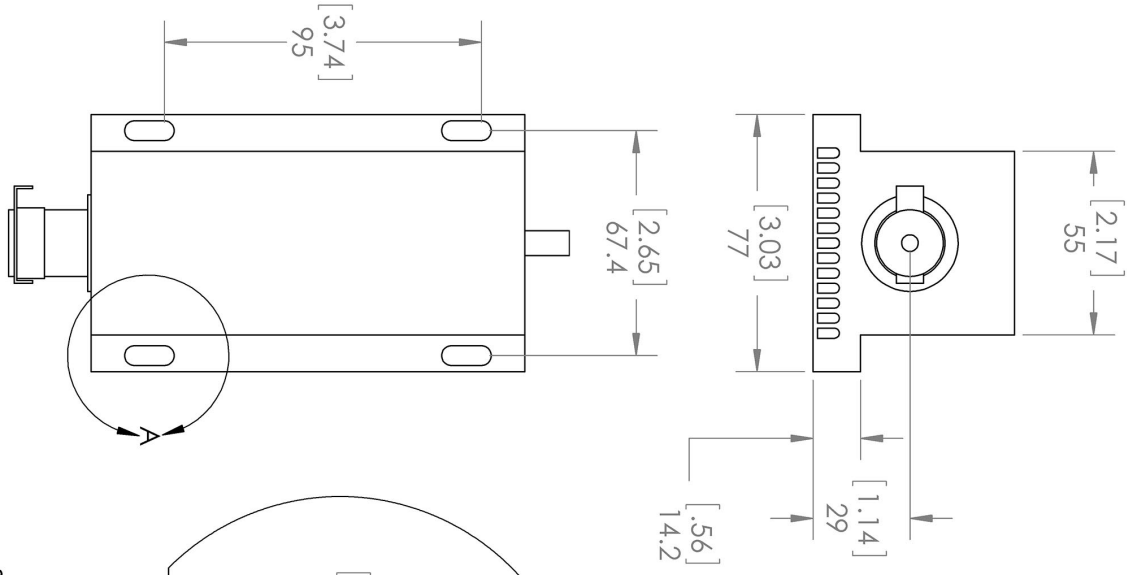

DETAIL A
SCALE 3 : 2

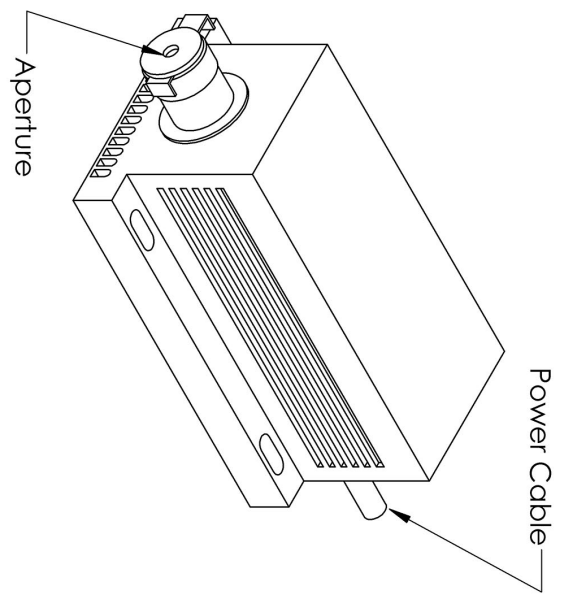
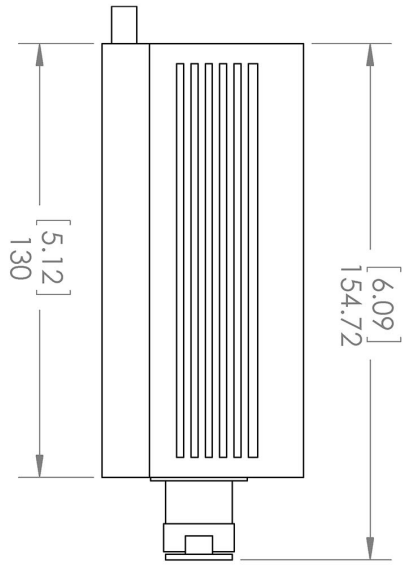

UNLESS OTHERWISE SPECIFIED: DIMENSIONS ARE IN MM(INCH) TOLERANCES: +/- 0.75 MM		TITLE: Laserglow Technologies	
THE INFORMATION CONTAINED IN THIS DRAWING IS THE SOLE PROPERTY OF LASERGLOW TECHNOLOGIES. ANY REPRODUCTION IN PART OR AS A WHOLE WITHOUT THE WRITTEN PERMISSION OF LASERGLOW TECHNOLOGIES IS PROHIBITED. © 2012 LASERGLOW.COM LIMITED. ALL RIGHTS RESERVED		SCALE: 1:2	
Lab/OEM H/T Housing		SHEET 1 OF 1	
REV 1		1	

Dimensional Drawing - Power Supply Form Factor: SH:

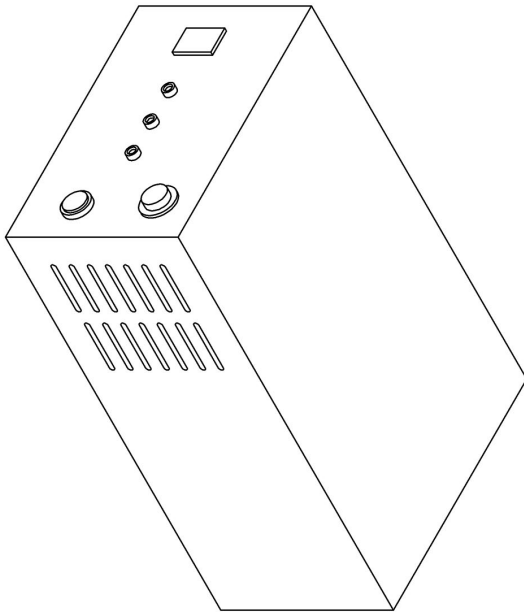
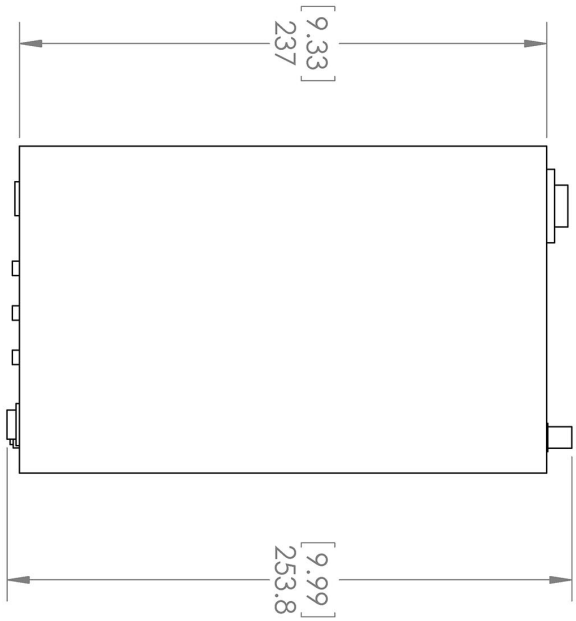
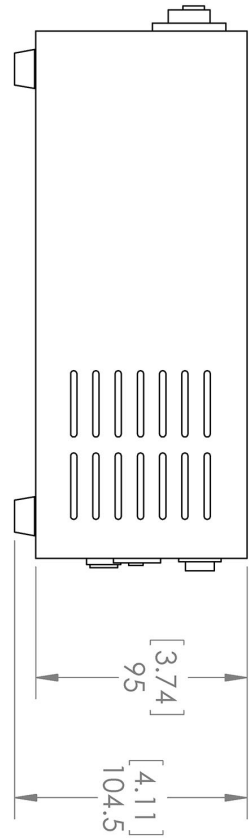
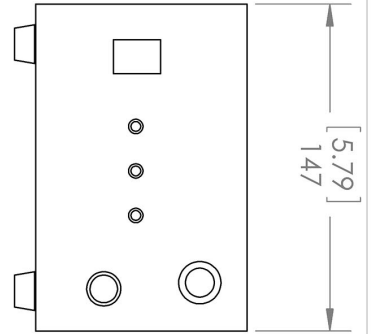

UNLESS OTHERWISE SPECIFIED:
 DIMENSIONS ARE IN MM(INCH)
 TOLERANCES: +/- 0.75 MM







THE INFORMATION CONTAINED IN THIS
 DRAWING IS THE SOLE PROPERTY OF
 LASERGLOW TECHNOLOGIES. ANY
 REPRODUCTION IN PART OR AS A WHOLE
 WITHOUT THE WRITTEN PERMISSION OF
 LASERGLOW TECHNOLOGIES IS
 PROHIBITED. © 2012 LASERGLOW.COM
 LIMITED. ALL RIGHTS RESERVED

TITLE: Power Supply SH/SF/SN REV 1	
SCALE: 1:3	SHEET 1 OF 1

Laserglow Technologies

Accessories:

The most popular accessories for model Q53-H are shown below. For additional details regarding these or other accessories please see our website or contact us directly.

Part Number	Description	
 AFF2002XX	Armored Fiber With FC/PC Connectors 200um Core Multimode 2m length Full Details: www.arktislaser.com/AFF	
 AFS2002XX	Armored Fiber With SMA 905 Connectors 200um Core Multimode 2 m length Full Details: www.arktislaser.com/AFS	
 AGF5327XX	LSG-532-NF-7 Fit-Over Safety Goggles 532nm Output: OD 7+ at 190-532 nm CE Certified Full Details: www.arktislaser.com/AGF	
 ACFVISHXA	FC/PC Fiber Coupler/Collimator for visible spectrum wavelengths (400 to 700 nm) (installed and aligned) 11mm diameter input lens Full Details: www.arktislaser.com/ACF	
 ACSVISHXA	SMA-905 Fiber Coupler/Collimator for visible spectrum wavelengths (400 to 700 nm) (installed and aligned) 11mm diameter input lens Full Details: www.arktislaser.com/ACS	
 ACALBHFXX	Carrying Case-103 Holds Lab/OEM H, F and O size Standard/LabSpec laser Full Details: www.arktislaser.com/ACA	Included With Laser

FOR MORE INFORMATION PLEASE CONTACT:

Arktis Laser
112 Elizabeth St, Unit 5-331, Toronto, ON, Canada M5G 1P5
Tel. 1-416-886-1178 Fax 1-647-874-7129
sales@arktislaser.com www.arktislaser.com

E&OE: Data included in this sheet may be subject to change without notice.

Please confirm critical specifications with our staff prior to ordering.