

LQS-1047 Passively Q-Switched Laser System



Series Specifications:

Nominal Wavelength	1047 nm
Output Type	Q-Switched
Laser Source Type	DPSS

Overview:

The LQS-1047 Series of Diode-Pumped Solid-State (DPSS) Q-Switched Lasers are ideal for applications requiring a very high peak power or short pulse duration at 1047 nm.

These lasers are commonly used for Raman spectroscopy, material processing, and a broad range of other applications. The driver is available as a plug-and-play benchtop system or an O.E.M. component designed for system integration.

Key Features:

- Pulse energy of 20 μ J - 70 μ J
- Pulse repetition rate of 1 Hz - 4 kHz
- Pulse duration in the range of 6-10 ns
- Air cooled
- Runs on standard AC power (85 - 264 V, 47 - 63 Hz)
- 10,000 hour maintenance-free operating life (Expected)
- FDA/CDRH compliant Class IV enclosure

Package Includes:

- Laser Head
- Driver/Power Supply
- Power Cable
- BNC Connector (LabSpec models only)
- Keys, Safety Interlock
- Hard-shell Carrying Case

Specifications:

This spec sheet has been generated specifically for part number QA4-M, per your request, and data for the entire series is also displayed for your reference. The specs which are specific to QA4-M have been highlighted below in **red + bold**.

Output Power (mW)	>70	>80, >200
Single Pulse Energy (μ J)	70	20, 50
Optimal Pulse Frequency (Hz)	1000	4000
Output Power Stability (%RMS/4h)	<1, <3, <5, <10	<1, <3, <5, <10
Wavelength Tolerance (+/- nm)	1	1
Divergence (mrad, full angle)	<2	<1.5
Beam Dimensions (mm, $1/e^2$)	3	1.5
Warm-up Time (minutes)	10	10
Avg. Pulse Duration (ns)	6	10
Approximate Peak Power (W)	25000	4500
Optical Noise Amplitude (%RMS @ 20 Hz - 20 MHz)	<20	<20
M ²	<1.5	<1.2
Beam Pointing Stability (mrad)	<0.05	<0.05
Operating Temperature Range (°C)	10 to 35	10 to 35
Max. TTL Modulation Freq. (Hz)	20000	20000
Minimum Pulsing Frequency (Hz)	0.1	1
Modulation Input Signal	0-5 VDC	0-5 VDC
Max. Power Input Duty Cycle	100%	100%
Standard Warranty (months)	12	12
MTTF (operational hours)	10000	10000
Weight of Product or Laser Head (kg)	0.9	0.6
Beam Height from Base Plate (mm)	29	24.8
Dimensions of Product or Laser Head (mm)	155 (l) x 77 (w) x 60 (h)	140.8 (l) x 73 (w) x 46.2 (h)

CW: All specifications are based on performance at full output power and after the specified warmup period. Output characteristics may change if the laser is run at a different power level.

Q-Switched: Specifications are based on the laser pulsing at the specified design frequency. Output characteristics may change if the laser is run at a different frequency.

Power Supply Options:

These lasers are available with several different power supply options. The model that you have selected is highlighted below, and any other options are shown for easy reference.

	Power Supply Type:	SM	SH
 FDA-Compliant Standard	Input Power	85v to 264v	85v to 264v
	Power Supply Weight (kg)	1.2	2.3
	Dimensions (mm)	133 (l) x 130 (w) x 65 (h)	238 (l) x 146 (w) x 102 (h)

*Power supply may not be exactly as shown, see dimensional drawings on next 2 pages.

*Dimensions for fiber-integrated (I_) include laser head packaged inside.

Regulatory Classification:

The model you have selected (QA4-M) requires the following safety label(s):



Dimensional Drawing - Laser Form Factor: M:

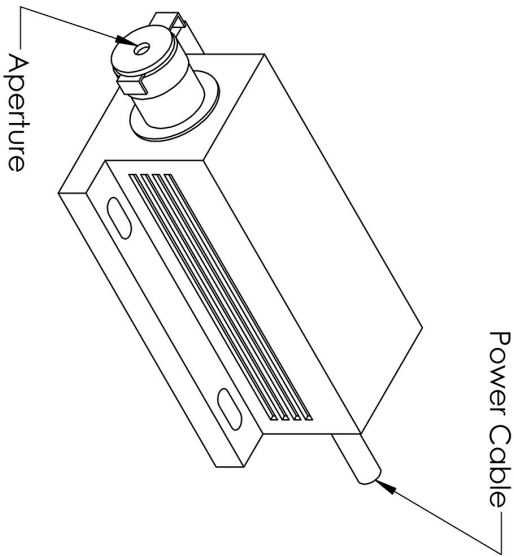

DETAIL A
SCALE 1 : 1

UNLESS OTHERWISE SPECIFIED:

DIMENSIONS ARE IN MM(INCH)

TOLERANCES: +/- 0.75 MM

THE INFORMATION CONTAINED IN THIS DRAWING IS THE SOLE PROPERTY OF LASERGLOW TECHNOLOGIES. ANY REPRODUCTION IN PART OR AS A WHOLE WITHOUT THE WRITTEN PERMISSION OF LASERGLOW TECHNOLOGIES IS PROHIBITED. © 2012 LASERGLOW.COM LIMITED. ALL RIGHTS RESERVED

Laserglow Technologies

TITLE:

Lab/OEM
M/R Housing REV 1

SCALE: 1:2

SHEET 1 OF 1

Dimensional Drawing - Power Supply Form Factor: SM:









UNLESS OTHERWISE SPECIFIED:
 DIMENSIONS ARE IN MM(INCH)
 TOLERANCES: +/- 0.75 MM

THE INFORMATION CONTAINED IN THIS DRAWING IS THE SOLE PROPERTY OF LASERGLOW TECHNOLOGIES. ANY REPRODUCTION IN PART OR AS A WHOLE WITHOUT THE WRITTEN PERMISSION OF LASERGLOW TECHNOLOGIES IS PROHIBITED. © 2012 LASERGLOW.COM LIMITED. ALL RIGHTS RESERVED

TITLE: Power Supply SM/SR REV 1		
SCALE: 1:2	SHEET 1 OF 1	Laserglow Technologies

Accessories:

The most popular accessories for model QA4-M are shown below. For additional details regarding these or other accessories please see our website or contact us directly.

Part Number	Description	
 AGFA647XX	LSG-1064-NF-7 Fit-Over Safety Goggles 1064nm Output: OD 7+ at 950-1070 nm CE Certified Full Details: www.arktislaser.com/AGF	
 ACFMIRHXA	FC/PC Fiber Coupler/Collimator for IR wavelengths (1000 to 1300 nm) (installed and aligned) 11mm diameter input lens Full Details: www.arktislaser.com/ACF	
 ACSMIRHXA	SMA-905 Fiber Coupler/Collimator for IR wavelengths (1000 to 1300 nm) (installed and aligned) 11mm diameter input lens Full Details: www.arktislaser.com/ACS	
 ACALBMXXX	Carrying Case-102 Holds Lab/OEM M, R and S size, standard or LabSpec laser Full Details: www.arktislaser.com/ACA	Included With Laser
 AFS2002XX	Armored Fiber With SMA 905 Connectors 200um Core Multimode 2 m length Full Details: www.arktislaser.com/AFS	
 AFF2002XX	Armored Fiber With FC/PC Connectors 200um Core Multimode 2m length Full Details: www.arktislaser.com/AFF	

FOR MORE INFORMATION PLEASE CONTACT:

Arktis Laser
112 Elizabeth St, Unit 5-331, Toronto, ON, Canada M5G 1P5
Tel. 1-416-886-1178 Fax 1-647-874-7129
sales@arktislaser.com www.arktislaser.com

E&OE: Data included in this sheet may be subject to change without notice.

Please confirm critical specifications with our staff prior to ordering.