

# Arktis Laser Product Datasheet

## LRS-00320 DPSS Laser System



### Series Specifications:

Nominal Wavelength	320 nm
Output Type	CW
Laser Source Type	DPSS

### Overview:

The LRS-0320 Series of Diode-Pumped Solid-State (DPSS) Lasers are ideal for applications requiring up to 25 mW of 320 nm UV laser light with a long operating lifetime at an aggressively competitive cost.

These lasers are commonly used for fluorescence excitation and a broad spectrum of other applications. The driver is available as a complete FDA-compliant system or as an O.E.M. component with significantly reduced dimensions.

Laserglow products are currently being used by some of the World's top universities and other prominent research facilities.

### Key Features:

- Air cooled - no need for water cooling or external chiller
- Lightweight, compact design
- Efficient DPSS technology runs on standard AC power (85 - 264 V, 47 - 63 Hz)
- >10,000 hours continuous maintenance-free operating life
- TTL and Analog modulation (input via BNC connector) *lab-spec models only*
- Adjustable output power (via lockable dial) *lab-spec models only*
- LED display showing LD current, laser cavity temperature *lab-spec models only*
- FDA CDRH Compliant Class IIIb / Class IV enclosure
- 48-hour replacement coverage available for an additional fee on specific models

### Package Includes:

- Laser Head
- Driver/Power Supply
- Power Cable
- Keys, Safety Interlock
- Hard-shell Carrying Case

## Specifications:

This spec sheet has been generated specifically for part number R32-F, per your request, and data for the entire series is also displayed for your reference. The specs which are specific to R32-F have been highlighted below in **red + bold**.

Output Power (mW)	<b>&gt;3, &gt;5, &gt;10, &gt;20</b>
Output Power Stability (%RMS/4h)	<b>&lt;3, &lt;5</b>
Central Wavelength (nm)	<b>320</b>
Wavelength Tolerance (+/- nm)	<b>1</b>
Divergence (mrad, full angle)	<b>&lt;2</b>
Beam Dimensions (mm, 1/e <sup>2</sup> )	<b>3</b>
Warm-up Time (minutes)	<b>10</b>
M <sup>2</sup>	<b>&lt;2</b>
Polarization Ratio	<b>&gt;50</b>
Beam Pointing Stability (mrad)	<b>&lt;0.05</b>
Operating Temperature Range (°C)	<b>10 to 35</b>
Max. Analog Modulation Freq. (Hz)	<b>10000</b>
Max. TTL Modulation Freq. (Hz)	<b>10000</b>
Modulation Input Signal	<b>0-5 VDC</b>
Max. Power Input Duty Cycle	<b>100%</b>
Standard Warranty (months)	<b>12</b>
MTTF (operational hours)	<b>10000</b>
Weight of Product or Laser Head (kg)	<b>1.6</b>
Beam Height from Base Plate (mm)	<b>45</b>
Dimensions of Product or Laser Head (mm)	<b>211.5 (l) x 88 (w) x 74 (h)</b>

CW: All specifications are based on performance at full output power and after the specified warmup period. Output characteristics may change if the laser is run at a different power level.

Q-Switched: Specifications are based on the laser pulsing at the specified design frequency. Output characteristics may change if the laser is run at a different frequency.

## Power Supply Options:

These lasers are available with several different power supply options. The model that you have selected is highlighted below, and any other options are shown for easy reference.

	Power Supply Type:	<b>FF</b>
FDA-Compliant LabSpec 	Input Power	<b>85v to 264v</b>
	Power Supply Weight (kg)	<b>2.6</b>
	Dimensions (mm)	<b>268 (l) x 145 (w) x 106 (h)</b>

\*Power supply may not be exactly as shown, see dimensional drawings on next 2 pages.

\*Dimensions for fiber-integrated (I\_) include laser head packaged inside.

## Regulatory Classification:

The model you have selected (R32-F) requires the following safety label(s):



**Dimensional Drawing - Laser Form Factor: F:**

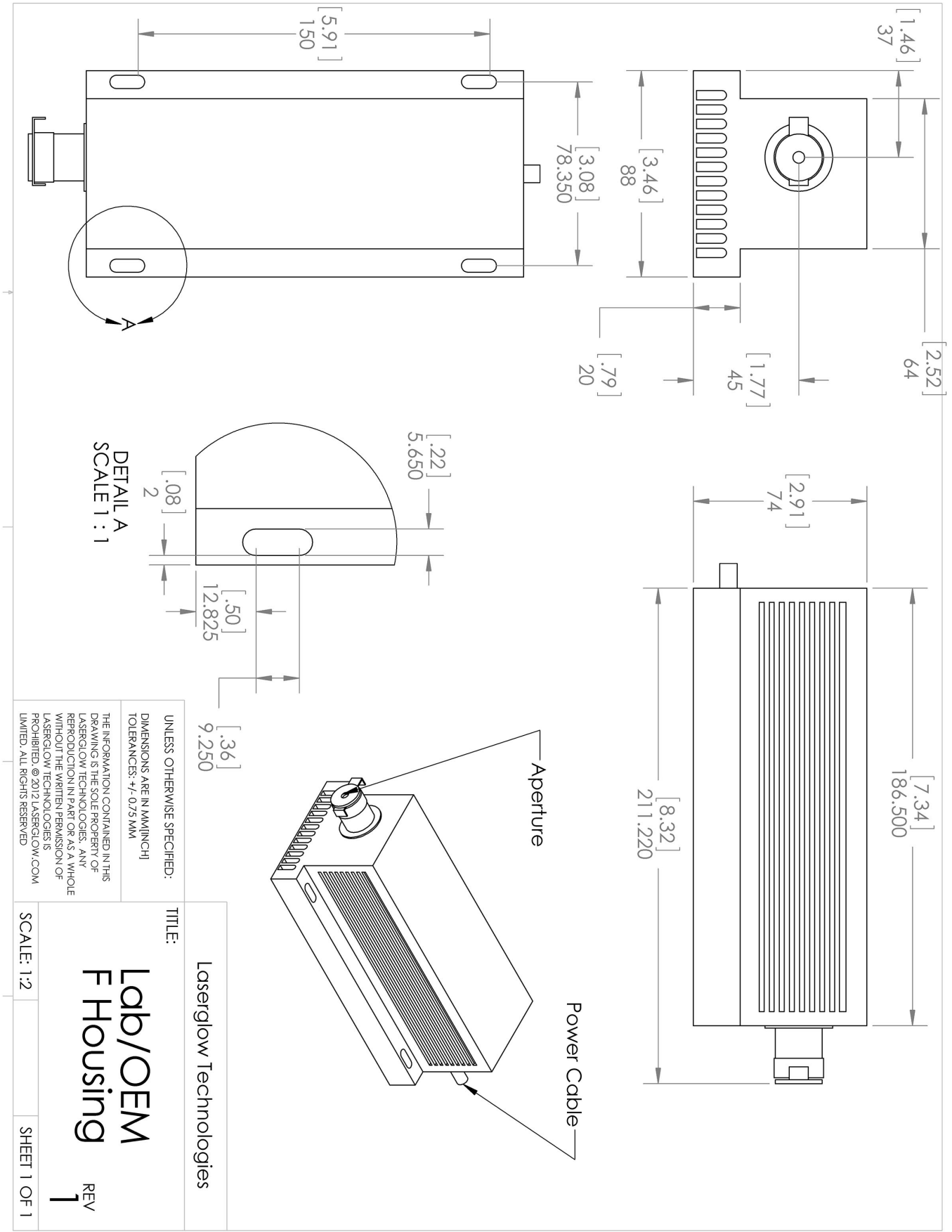

UNLESS OTHERWISE SPECIFIED:  
 DIMENSIONS ARE IN MILLIMETER  
 TOLERANCES: +/- 0.075 MM

TITLE:  
**Lab/OEM  
 F Housing**  
 REV 1

Loserglow Technologies

SCALE: 1:2 SHEET 1 OF 1

THE INFORMATION CONTAINED IN THIS DRAWING IS THE SOLE PROPERTY OF LASERGLLOW TECHNOLOGIES. ANY REPRODUCTION IN PART OR AS A WHOLE WITHOUT THE WRITTEN PERMISSION OF LASERGLLOW TECHNOLOGIES IS PROHIBITED. © 2012 LASERGLLOW.COM LIMITED. ALL RIGHTS RESERVED

**Dimensional Drawing - Power Supply Form Factor: FF:**

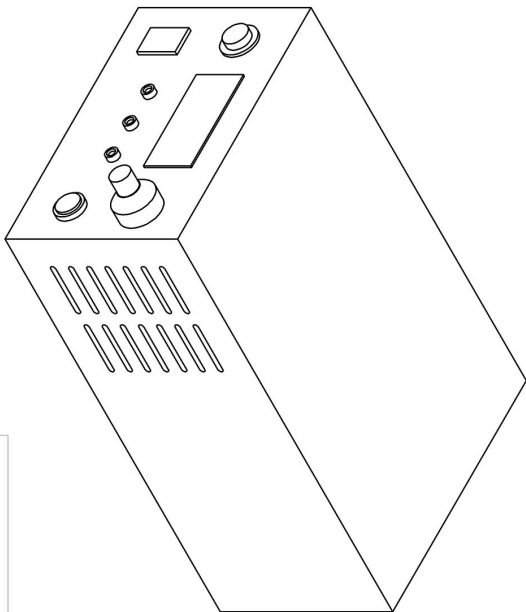
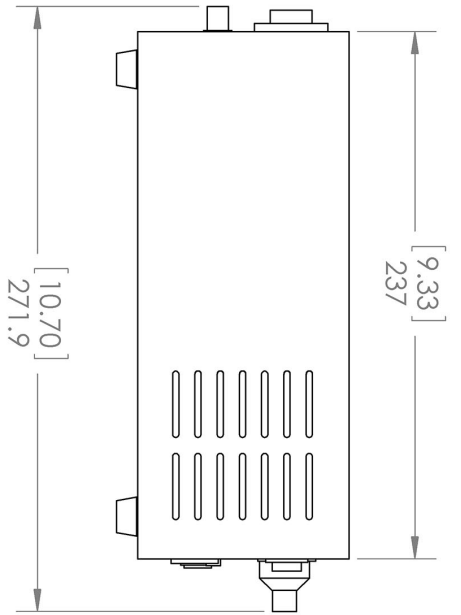
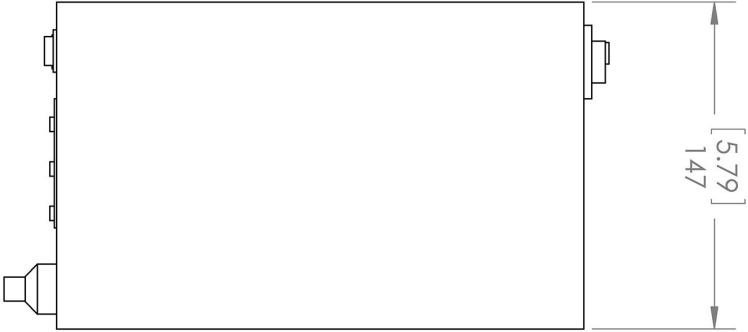
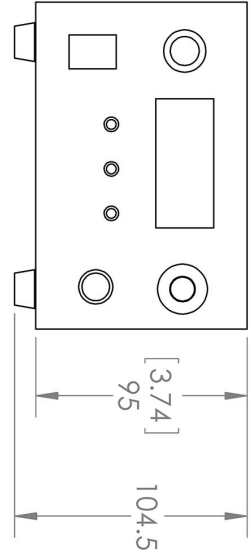

UNLESS OTHERWISE SPECIFIED:  
 DIMENSIONS ARE IN MM(INCH)  
 TOLERANCES: +/- 0.75 MM

THE INFORMATION CONTAINED IN THIS DRAWING IS THE SOLE PROPERTY OF LASERGLOW TECHNOLOGIES. ANY REPRODUCTION IN PART OR AS A WHOLE WITHOUT THE WRITTEN PERMISSION OF LASERGLOW TECHNOLOGIES IS PROHIBITED. © 2012 LASERGLOW.COM LIMITED. ALL RIGHTS RESERVED

Laserglow Technologies

**Power Supply**  
**FH/FF/FN**







REV  
**1**

SCALE: 1:3

SHEET 1 OF 1

## Accessories:

The most popular accessories for model R32-F are shown below. For additional details regarding these or other accessories please see our website or contact us directly.

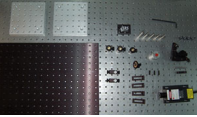
Part Number	Description	
 ACALBHFXX	Carrying Case-103 Holds Lab/OEM H, F and O size Standard/LabSpec laser Full Details: <a href="http://www.arktislaser.com/ACA">www.arktislaser.com/ACA</a>	Included With Laser
 AGF5327XX	LSG-532-NF-7 Fit-Over Safety Goggles 532nm Output: OD 7+ at 190-532 nm CE Certified Full Details: <a href="http://www.arktislaser.com/AGF">www.arktislaser.com/AGF</a>	
 AFS2002XX	Armored Fiber With SMA 905 Connectors 200um Core Multimode 2 m length Full Details: <a href="http://www.arktislaser.com/AFS">www.arktislaser.com/AFS</a>	
 AFF2002XX	Armored Fiber With FC/PC Connectors 200um Core Multimode 2m length Full Details: <a href="http://www.arktislaser.com/AFF">www.arktislaser.com/AFF</a>	
 ACSUV1HXA	SMA Fiber Coupler/Collimator for ultraviolet wavelengths (266 to 399 nm) (installed and aligned) 11mm diameter input lens Full Details: <a href="http://www.arktislaser.com/ACS">www.arktislaser.com/ACS</a>	
 ACFUV1HXA	FC/PC Fiber Coupler/Collimator for ultraviolet wavelengths (266 to 399 nm) (installed and aligned) 11mm diameter input lens Full Details: <a href="http://www.arktislaser.com/ACF">www.arktislaser.com/ACF</a>	
 TBKMF1001	Optics Kit Breadboard Mounting Kit for F-size Lasers Includes 9x4x0.5 riser, hardware Full Details: <a href="http://www.arktislaser.com/TBK">www.arktislaser.com/TBK</a>	

## FOR MORE INFORMATION PLEASE CONTACT:

Arktis Laser  
112 Elizabeth St, Unit 5-331, Toronto, ON, Canada M5G 1P5  
Tel. 1-416-886-1178 Fax 1-647-874-7129  
[sales@arktislaser.com](mailto:sales@arktislaser.com) [www.arktislaser.com](http://www.arktislaser.com)

E&OE: Data included in this sheet may be subject to change without notice.  
Please confirm critical specifications with our staff prior to ordering.