

LRS-0491 DPSS Laser System



Series Specifications:

Nominal Wavelength	491 nm
Output Type	CW
Laser Source Type	DPSS

Overview:

The LRS-0491 Series of Diode-Pumped Solid-State (DPSS) Lasers are ideal for applications requiring >1 mW to >2 mW of 491 nm laser light with guaranteed long-term output power stability and long operating lifetime.

These lasers are commonly used for fluorescence excitation, PIV, Raman Spectroscopy, and a broad spectrum of other applications. The driver is available as a complete FDA-compliant system or as an O.E.M. component with significantly reduced dimensions.

Key Features:

- Air cooled - no need for water cooling or external chiller
- Lightweight, compact design
- Efficient DPSS technology runs on standard AC power (85 - 264 V, 47 - 63 Hz)
- >10,000 hours continuous maintenance-free operating life
- TTL and Analog modulation (input via BNC connector) *lab-spec models only*
- Adjustable output power (via lockable dial) *lab-spec models only*
- LED display showing LD current, laser cavity temperature *lab-spec models only*
- FDA CDRH Compliant Class IIb / Class IV enclosure
- 48-hour replacement coverage available for an additional fee on specific models

Package Includes:

- Laser Head
- Driver/Power Supply
- Power Cable
- Keys, Safety Interlock
- Hard-shell Carrying Case

Specifications:

This spec sheet has been generated specifically for part number R49-H, per your request, and data for the entire series is also displayed for your reference. The specs which are specific to R49-H have been highlighted below in **red + bold**.

Output Power (mW)	>1, >2	>5, >10, >30, >50, >100, >200, >300, >400, >500
Output Power Stability (%RMS/4h)	<10	<3, <5, <10
Wavelength Tolerance (+/- nm)	1	1
Divergence (mrad, full angle)	<1.5	<3
Beam Dimensions (mm, 1/e ²)	3	4
Warm-up Time (minutes)	10	10
Optical Noise Amplitude (%RMS @ 20 Hz - 20 MHz)	<30	
M ²	<1.2	
Polarization Ratio	>100	>100
Beam Pointing Stability (mrad)	<0.05	
Operating Temperature Range (°C)	10 to 35	10 to 35
Max. Analog Modulation Freq. (Hz)		30000
Max. TTL Modulation Freq. (Hz)	10000	10000, 30000
Modulation Input Signal	0-5 VDC	0-5 VDC
Max. Power Input Duty Cycle	100%	100%
Standard Warranty (months)	12	12
MTTF (operational hours)	10000	10000
Weight of Product or Laser Head (kg)	0.9	7.5
Beam Height from Base Plate (mm)	29	96.4
Dimensions of Product or Laser Head (mm)	155 (l) x 77 (w) x 60 (h)	226 (l) x 150 (w) x 135 (h)

CW: All specifications are based on performance at full output power and after the specified warmup period. Output characteristics may change if the laser is run at a different power level.

Q-Switched: Specifications are based on the laser pulsing at the specified design frequency. Output characteristics may change if the laser is run at a different frequency.

Power Supply Options:

These lasers are available with several different power supply options. The model that you have selected is highlighted below, and any other options are shown for easy reference.

	Power Supply Type:	FW
FDA-Compliant LabSpec 	Input Power	85v to 264v
	Power Supply Weight (kg)	5.2
	Dimensions (mm)	307 (l) x 168 (w) x 123 (h)

	Power Supply Type:	SW	SH
FDA-Compliant Standard 	Input Power	85v to 264v	85v to 264v
	Power Supply Weight (kg)	5.1	2.3
	Dimensions (mm)	307 (l) x 168 (w) x 123 (h)	238 (l) x 146 (w) x 102 (h)

*Power supply may not be exactly as shown, see dimensional drawings on next 2 pages.

*Dimensions for fiber-integrated (I_) include laser head packaged inside.

Regulatory Classification:

The model you have selected (R49-H) requires the following safety label(s):



Dimensional Drawing - Laser Form Factor: H:



DETAIL A
SCALE 3 : 2

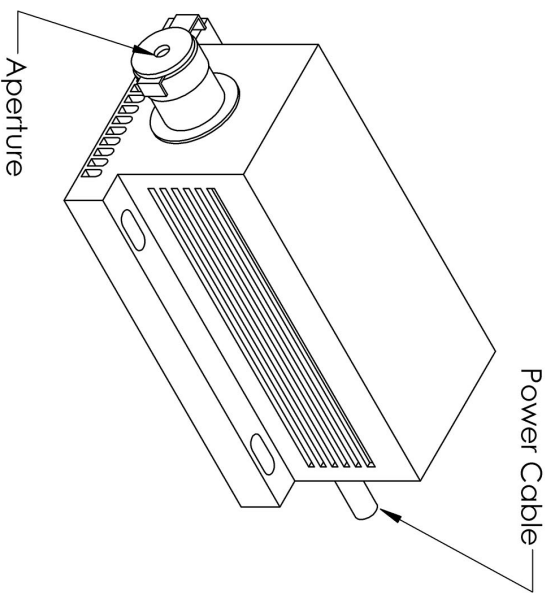
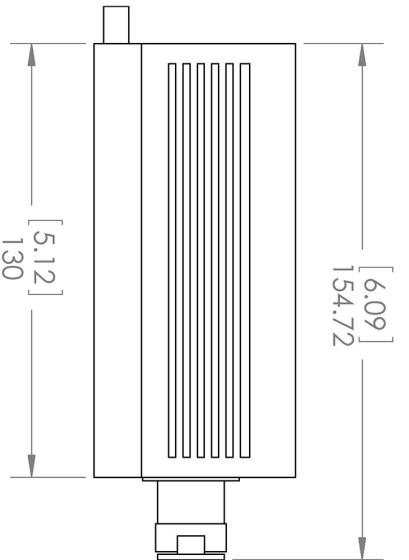

UNLESS OTHERWISE SPECIFIED: DIMENSIONS ARE IN MILLIMETER TOLERANCES: +/- 0.075 MM		TITLE: Laserglow Technologies	
THE INFORMATION CONTAINED IN THIS DRAWING IS THE SOLE PROPERTY OF LASERGLOW TECHNOLOGIES. ANY REPRODUCTION IN PART OR AS A WHOLE WITHOUT THE WRITTEN PERMISSION OF LASERGLOW TECHNOLOGIES IS PROHIBITED. © 2012 LASERGLOW.COM LIMITED. ALL RIGHTS RESERVED		SCALE: 1:2	
Lab/OEM H/T Housing		SHEET 1 OF 1	
REV 1		1	

Dimensional Drawing - Power Supply Form Factor: SH:

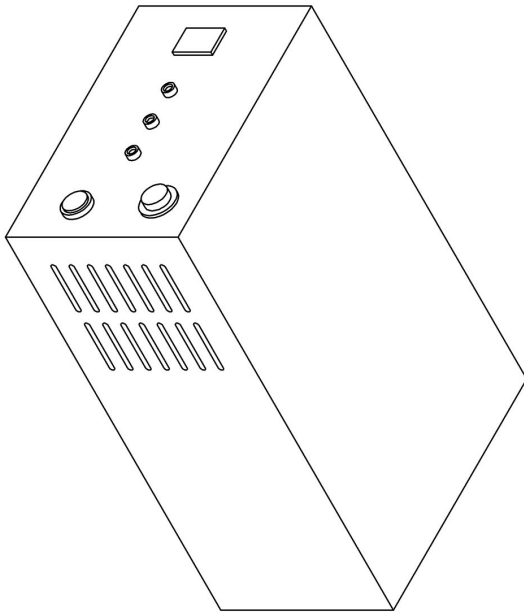
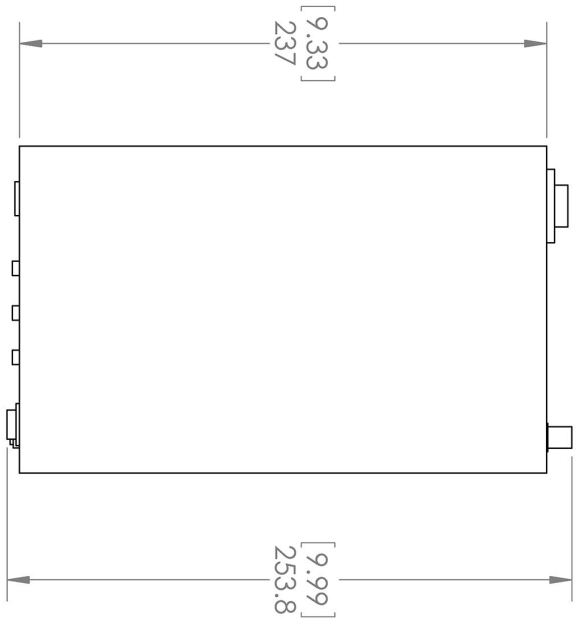

UNLESS OTHERWISE SPECIFIED:
 DIMENSIONS ARE IN MM(INCH)
 TOLERANCES: +/- 0.75 MM

THE INFORMATION CONTAINED IN THIS DRAWING IS THE SOLE PROPERTY OF LASERGLOW TECHNOLOGIES. ANY REPRODUCTION IN PART OR AS A WHOLE WITHOUT THE WRITTEN PERMISSION OF LASERGLOW TECHNOLOGIES IS PROHIBITED. © 2012 LASERGLOW.COM LIMITED. ALL RIGHTS RESERVED

Laserglow Technologies

TITLE:

**Power Supply
 SH/SF/SN**







REV
1

SCALE: 1:3

SHEET 1 OF 1

Accessories:

The most popular accessories for model R49-H are shown below. For additional details regarding these or other accessories please see our website or contact us directly.

Part Number	Description	
 AFF2002XX	Armored Fiber With FC/PC Connectors 200um Core Multimode 2m length Full Details: www.arktislaser.com/AFF	
 AFS2002XX	Armored Fiber With SMA 905 Connectors 200um Core Multimode 2 m length Full Details: www.arktislaser.com/AFS	
 AGF5327XX	LSG-532-NF-7 Fit-Over Safety Goggles 532nm Output: OD 7+ at 190-532 nm CE Certified Full Details: www.arktislaser.com/AGF	
 ACFVISHXA	FC/PC Fiber Coupler/Collimator for visible spectrum wavelengths (400 to 700 nm) (installed and aligned) 11mm diameter input lens Full Details: www.arktislaser.com/ACF	
 ACSVISHXA	SMA-905 Fiber Coupler/Collimator for visible spectrum wavelengths (400 to 700 nm) (installed and aligned) 11mm diameter input lens Full Details: www.arktislaser.com/ACS	
 ACALBHFXX	Carrying Case-103 Holds Lab/OEM H, F and O size Standard/LabSpec laser Full Details: www.arktislaser.com/ACA	Included With Laser
 TBK	Complete optics kits with breadboard mounting hardware. External modulators, variable attenuators, free-space fiber launch systems Full Details: www.arktislaser.com/TBK	

FOR MORE INFORMATION PLEASE CONTACT:

Arktis Laser
112 Elizabeth St, Unit 5-331, Toronto, ON, Canada M5G 1P5
Tel. 1-416-886-1178 Fax 1-647-874-7129
sales@arktislaser.com www.arktislaser.com

E&OE: Data included in this sheet may be subject to change without notice.

Please confirm critical specifications with our staff prior to ordering.