

## LRS-0946 DPSS Laser System



### Series Specifications:

Nominal Wavelength	946 nm
Output Type	CW
Laser Source Type	DPSS

### Overview:

The LRS-0946 Series of Diode-Pumped Solid-State (DPSS) Lasers are ideal for applications requiring 50 mW to >800 mW of 946 nm laser light with a high level of long-term output power stability and long operating lifetime at an aggressively competitive cost.

These lasers are commonly used for various scientific applications such as measurement, communications research, spectral analysis, and a broad spectrum of other applications. The driver is available as a complete FDA-compliant system or as an O.E.M. component with significantly reduced dimensions.

Available with both on-board and remote on/off control as well as a wide array of output power and stability levels, Laserglow products are currently being used by some of the World's top universities and other prominent research facilities.

### Key Features:

- Air cooled - no need for water cooling or external chiller
- Lightweight, compact design
- Efficient DPSS technology runs on standard AC power (85 - 264 V, 47 - 63 Hz)
- >10,000 hours continuous maintenance-free operating life
- TTL and Analog modulation (input via BNC connector) *lab-spec models only*
- Adjustable output power (via lockable dial) *lab-spec models only*
- LED display showing LD current, laser cavity temperature *lab-spec models only*
- FDA CDRH Compliant Class IIIb / Class IV enclosure
- 48-hour replacement coverage available for an additional fee on specific models

### Package Includes:

- Laser Head
- Driver/Power Supply
- Power Cable
- BNC Connector (LabSpec models only)
- Keys, Safety Interlock
- Hard-shell Carrying Case

## Specifications:

This spec sheet has been generated specifically for part number R94-H, per your request, and data for the entire series is also displayed for your reference. The specs which are specific to R94-H have been highlighted below in **red + bold**.

Output Power (mW)	>50, >100, >200, >300	<b>&gt;500, &gt;800</b>
Output Power Stability (%RMS/4h)	<3, <5, <10	<b>&lt;3, &lt;5, &lt;10</b>
Central Wavelength (nm)	945.16	<b>945.16</b>
Wavelength Tolerance (+/- nm)	1	<b>1</b>
Divergence (mrad, full angle)	<1.5	<b>&lt;2</b>
Beam Dimensions (mm, 1/e <sup>2</sup> )	1.5	<b>3</b>
Warm-up Time (minutes)	10	<b>10</b>
M <sup>2</sup>	<1.5	<b>&lt;2</b>
Beam Pointing Stability (mrad)	<0.05	<b>&lt;0.05</b>
Operating Temperature Range (°C)	10 to 35	<b>10 to 35</b>
Max. Analog Modulation Freq. (Hz)	500	<b>500</b>
Max. TTL Modulation Freq. (Hz)	500	<b>500</b>
Modulation Input Signal	0-5 VDC	<b>0-5 VDC</b>
Total Power Consumption (W)	28, 30	
Max. Power Input Duty Cycle	100%	<b>100%</b>
Standard Warranty (months)	12	<b>12</b>
MTTF (operational hours)	10000	<b>10000</b>
Weight of Product or Laser Head (kg)	0.6	<b>0.9</b>
Beam Height from Base Plate (mm)	24.8	<b>29</b>
Dimensions of Product or Laser Head (mm)	140.8 (l) x 73 (w) x 46.2 (h)	<b>155 (l) x 77 (w) x 60 (h)</b>

CW: All specifications are based on performance at full output power and after the specified warmup period. Output characteristics may change if the laser is run at a different power level.

Q-Switched: Specifications are based on the laser pulsing at the specified design frequency. Output characteristics may change if the laser is run at a different frequency.

## Power Supply Options:

These lasers are available with several different power supply options. The model that you have selected is highlighted below, and any other options are shown for easy reference.

	Power Supply Type:	<b>FM</b>	<b>FH</b>
FDA-Compliant LabSpec 	Input Power	85v to 264v	<b>85v to 264v</b>
	Power Supply Weight (kg)	1.5	<b>2.6</b>
	Dimensions (mm)	154 (l) x 155 (w) x 95 (h)	<b>268 (l) x 145 (w) x 106 (h)</b>

	Power Supply Type:	<b>SM</b>	<b>SH</b>
FDA-Compliant Standard 	Input Power	85v to 264v	85v to 264v
	Power Supply Weight (kg)	1.2	2.3
	Dimensions (mm)	133 (l) x 130 (w) x 65 (h)	238 (l) x 146 (w) x 102 (h)

\*Power supply may not be exactly as shown, see dimensional drawings on next 2 pages.

\*Dimensions for fiber-integrated (I\_) include laser head packaged inside.

## Regulatory Classification:

The model you have selected (R94-H) requires the following safety label(s):

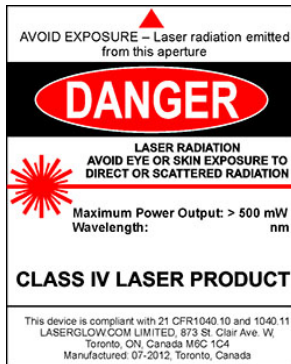

**Dimensional Drawing - Laser Form Factor: H:**



DETAIL A  
SCALE 3 : 2

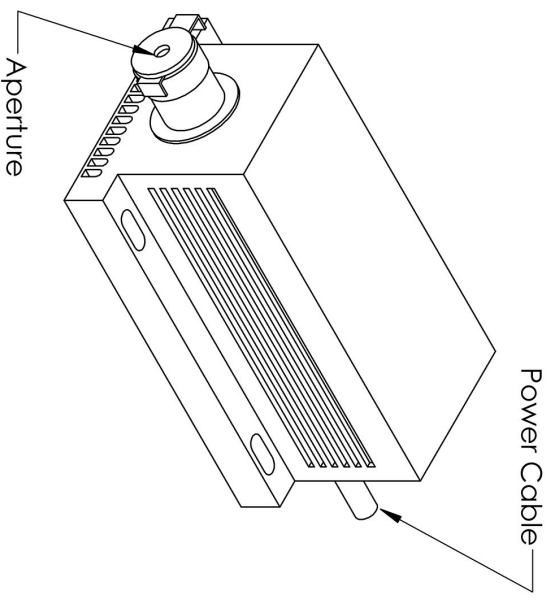
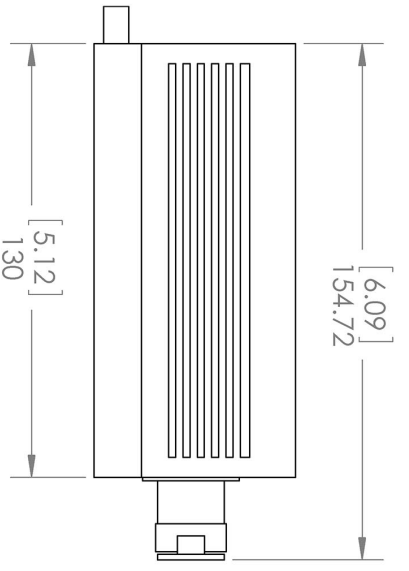

UNLESS OTHERWISE SPECIFIED: DIMENSIONS ARE IN MM(INCH) TOLERANCES: +/- 0.75 MM		TITLE: <b>Laserglow Technologies</b>	
THE INFORMATION CONTAINED IN THIS DRAWING IS THE SOLE PROPERTY OF LASERGLOW TECHNOLOGIES. ANY REPRODUCTION IN PART OR AS A WHOLE WITHOUT THE WRITTEN PERMISSION OF LASERGLOW TECHNOLOGIES IS PROHIBITED. © 2012 LASERGLOW.COM LIMITED. ALL RIGHTS RESERVED		SCALE: 1:2	
Lab/OEM <b>H/T Housing</b>		SHEET 1 OF 1	
REV 1		1	

**Dimensional Drawing - Power Supply Form Factor: FH:**

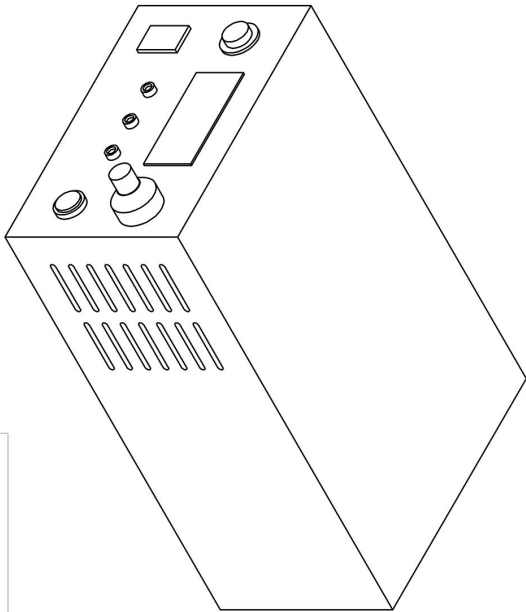
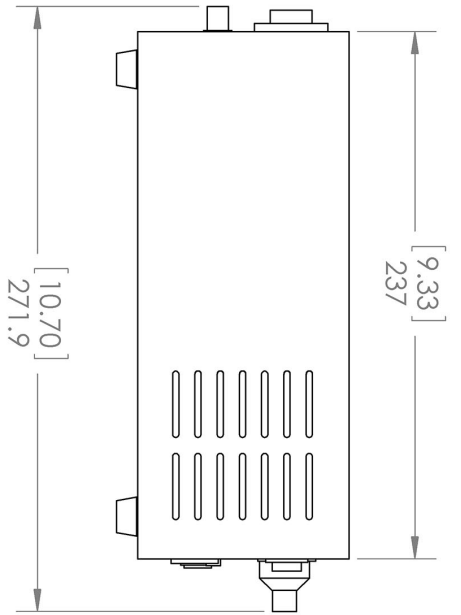
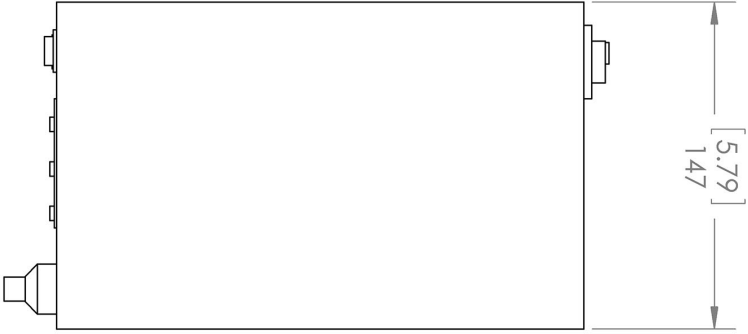
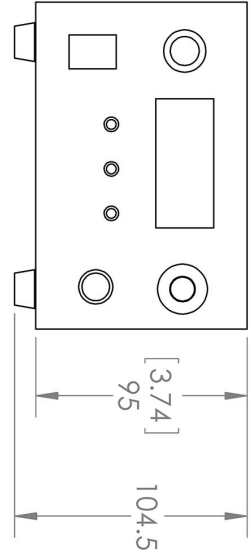

UNLESS OTHERWISE SPECIFIED:  
 DIMENSIONS ARE IN MM(INCH)  
 TOLERANCES: +/- 0.75 MM

THE INFORMATION CONTAINED IN THIS DRAWING IS THE SOLE PROPERTY OF LASERGLOW TECHNOLOGIES. ANY REPRODUCTION IN PART OR AS A WHOLE WITHOUT THE WRITTEN PERMISSION OF LASERGLOW TECHNOLOGIES IS PROHIBITED. © 2012 LASERGLOW.COM LIMITED. ALL RIGHTS RESERVED

**Laserglow Technologies**

TITLE:

**Power Supply**  
**FH/FF/FN**







REV  
**1**

SCALE: 1:3

SHEET 1 OF 1

## Accessories:

The most popular accessories for model R94-H are shown below. For additional details regarding these or other accessories please see our website or contact us directly.

Part Number	Description	
 AGFA647XX	LSG-1064-NF-7 Fit-Over Safety Goggles 1064nm Output: OD 7+ at 950-1070 nm CE Certified Full Details: <a href="http://www.arktislaser.com/AGF">www.arktislaser.com/AGF</a>	
 ACFNIRHXA	FC/PC Fiber Coupler/Collimator for IR wavelengths (700 to 1000 nm) (installed and aligned) 11mm diameter input lens Full Details: <a href="http://www.arktislaser.com/ACF">www.arktislaser.com/ACF</a>	
 ACSNIRHXA	SMA-905 Fiber Coupler/Collimator for IR wavelengths (700 to 1000nm) (installed and aligned) 11mm diameter input lens Full Details: <a href="http://www.arktislaser.com/ACS">www.arktislaser.com/ACS</a>	
 AFS2002XX	Armored Fiber With SMA 905 Connectors 200um Core Multimode 2 m length Full Details: <a href="http://www.arktislaser.com/AFS">www.arktislaser.com/AFS</a>	
 AFF2002XX	Armored Fiber With FC/PC Connectors 200um Core Multimode 2m length Full Details: <a href="http://www.arktislaser.com/AFF">www.arktislaser.com/AFF</a>	
 TBK	Complete optics kits with breadboard mounting hardware. External modulators, variable attenuators, free-space fiber launch systems Full Details: <a href="http://www.arktislaser.com/TBK">www.arktislaser.com/TBK</a>	
 ACALBHFXX	Carrying Case-103 Holds Lab/OEM H, F and O size Standard/LabSpec laser Full Details: <a href="http://www.arktislaser.com/ACA">www.arktislaser.com/ACA</a>	Included With Laser

## FOR MORE INFORMATION PLEASE CONTACT:

Arktis Laser  
112 Elizabeth St, Unit 5-331, Toronto, ON, Canada M5G 1P5  
Tel. 1-416-886-1178 Fax 1-647-874-7129  
[sales@arktislaser.com](mailto:sales@arktislaser.com) [www.arktislaser.com](http://www.arktislaser.com)

E&OE: Data included in this sheet may be subject to change without notice.  
Please confirm critical specifications with our staff prior to ordering.