

LRS-1064 DPSS Laser System



Series Specifications:

Nominal Wavelength	1064 nm
Output Type	CW
Laser Source Type	DPSS

Overview:

The LRS-1064 Series of Diode-Pumped Solid-State (DPSS) Lasers are ideal for applications requiring anywhere up to 200 W of 1064 nm laser light with the highest level of long-term output power stability and long operating lifetime at a highly competitive cost.

These lasers are commonly used for various scientific applications such as measurement, communications research, spectral analysis, and a broad spectrum of other applications. The driver is available as a complete FDA-compliant system or as an O.E.M. component with significantly reduced dimensions.

Available with both analog and TTL modulation as well as a wide array of output power and stability levels, Laserglow products are currently being used by some of the World's top universities and other prominent research facilities.

Key Features:

- Air cooled below 50W, closed-loop water cooling 50 W and above
- Lightweight, compact design
- Efficient DPSS technology runs on standard AC power (85 - 264 V, 47 - 63 Hz)
- >10,000 hours continuous maintenance-free operating life
- TTL and Analog modulation (input via BNC connector) *lab-spec models only*
- Adjustable output power (via lockable dial) *lab-spec models only*
- LED display showing LD current, laser cavity temperature *lab-spec models only*
- FDA CDRH Compliant Class IIIb / Class IV enclosure
- 48-hour replacement coverage available for an additional fee on specific models

Package Includes:

- Laser Head
- Driver/Power Supply
- Power Cable
- BNC Connector (LabSpec models only)
- Keys, Safety Interlock
- Hard-shell Carrying Case
- Water chiller included on models above 50 W

Specifications:

This spec sheet has been generated specifically for part number RA6-H, per your request, and data for the entire series is also displayed for your reference. The specs which are specific to RA6-H have been highlighted below in **red + bold**.

Output Power (mW)	>300, >500, >1000	>300, >500, >800, >1000, >1500	>2000, >3000	>4000, >5000	>8000, >10000, >15000, >20000	100,000, 200,000, >50000
Output Power Stability (%RMS/4h)	<1, <3, <5	<1, <3, <5	<1, <3, <5	<1, <3, <5	<1, <3, <5	<3, <5
Central Wavelength (nm)	1064	1063.2	1063.2	1063.2	1063.2	1063.2
Wavelength Tolerance (+/- nm)	1	1	1	1	1	1
Divergence (mrad, full angle)	<1.8	<1.5	<2	<1.5	<2	<3.5
Beam Dimensions (mm, 1/e ²)	1.2	1.5	3	3	2	6, 9
Warm-up Time (minutes)	5	10	10	10	10	10
M ²	<1.5	<1.5	<2	<3	<2, <3	
Polarization Ratio	>100	>100	>100	>100	>100	
Beam Pointing Stability (mrad)	<0.05	<0.05	<0.05	<0.05	<0.05	<0.05
IP rating	67					
Lateral Shock Tolerance (G's/6ms)	7					
Vertical Shock Tolerance (G's/6ms)	15					
Operating Temperature Range (°C)	1 to 60	10 to 35	10 to 35	10 to 35	10 to 35	15 to 35
Max. Analog Modulation Freq. (Hz)	30000	30000	30000	30000	30000	30000
Max. TTL Modulation Freq. (Hz)	30000	30000	30000	30000	30000	30000
Modulation Input Signal	0-5 VDC	0-5 VDC	0-5 VDC	0-5 VDC	0-5 VDC	0-5 VDC
Total Power Consumption (W)	40	30, 35	70		153	
Max. Power Input Duty Cycle	100%	100%	100%	100%	100%	100%
Standard Warranty (months)	12	12	12	12	12	12
MTTF (operational hours)	10000	10000	10000	10000	10000	10000
Weight of Product or Laser Head (kg)		0.6	0.9	2.6	6.1	15
Beam Height from Base Plate (mm)	19	24.8	29	68.2	93.5	65
Dimensions of Product or Laser Head (mm)	100 (l) x 50 (w) x 38 (h)	140.8 (l) x 73 (w) x 46.2 (h)	155 (l) x 77 (w) x 60 (h)	240 (l) x 99 (w) x 94 (h)	346 (l) x 140 (w) x 125 (h)	426 (l) x 150 (w) x 130 (h)

CW: All specifications are based on performance at full output power and after the specified warmup period. Output characteristics may change if the laser is run at a different power level.

Q-Switched: Specifications are based on the laser pulsing at the specified design frequency. Output characteristics may change if the laser is run at a different frequency.

Power Supply Options:

These lasers are available with several different power supply options. The model that you have selected is highlighted below, and any other options are shown for easy reference.

	Power Supply Type:	FS	FM	FW	FB	FH
FDA-Compliant LabSpec 	Input Power	85v to 264v	85v to 264v	85v to 264v	85v to 264v	85v to 264v
	Power Supply Weight (kg)	1.5	1.5	5.2	18.5	2.6
	Dimensions (mm)	154 (l) x 155 (w) x 95 (h)	154 (l) x 155 (w) x 95 (h)	307 (l) x 168 (w) x 123 (h)	340 (l) x 463 (w) x 221 (h)	268 (l) x 145 (w) x 106 (h)

*Power supply may not be exactly as shown, see dimensional drawings on next 2 pages.

*Dimensions for fiber-integrated (I_) include laser head packaged inside.

Regulatory Classification:

The model you have selected (RA6-H) requires the following safety label(s):



Dimensional Drawing - Laser Form Factor: H:



DETAIL A
SCALE 3 : 2

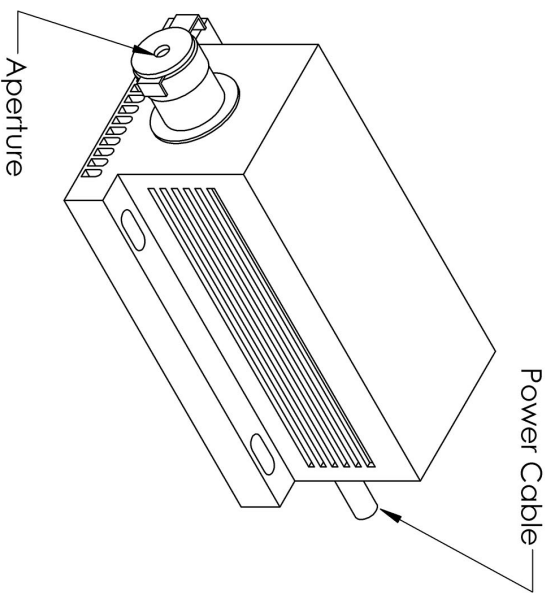
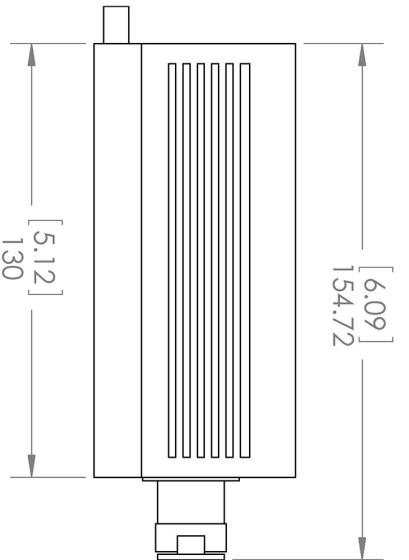

<p>UNLESS OTHERWISE SPECIFIED: DIMENSIONS ARE IN MILLIMETER TOLERANCES: +/- 0.75 MM</p>		<p>TITLE: Laserglow Technologies</p>	
<p>THE INFORMATION CONTAINED IN THIS DRAWING IS THE SOLE PROPERTY OF LASERGLOW TECHNOLOGIES. ANY REPRODUCTION IN PART OR AS A WHOLE WITHOUT THE WRITTEN PERMISSION OF LASERGLOW TECHNOLOGIES IS PROHIBITED. © 2012 LASERGLOW.COM LIMITED. ALL RIGHTS RESERVED</p>		<p>SCALE: 1:2</p>	
<p>Lab/OEM H/T Housing</p>		<p>REV 1</p>	
<p>SCALE: 1:2</p>		<p>SHEET 1 OF 1</p>	

Dimensional Drawing - Power Supply Form Factor: FH:

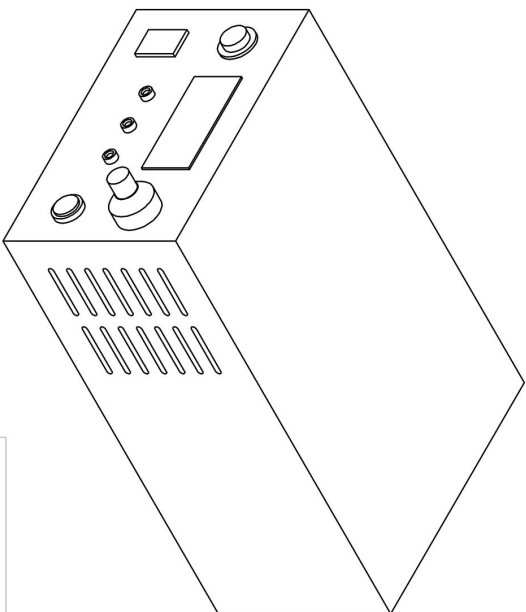
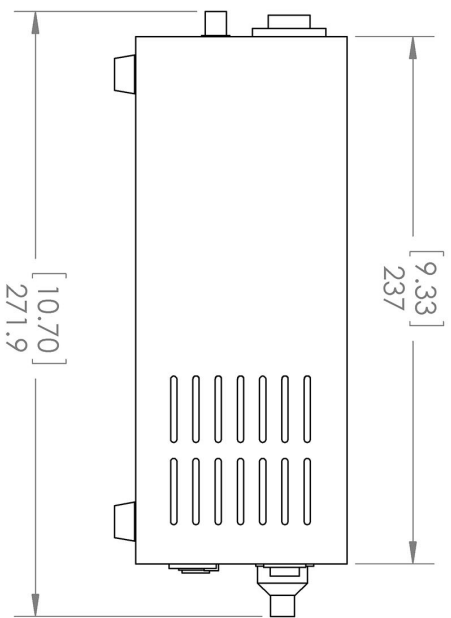
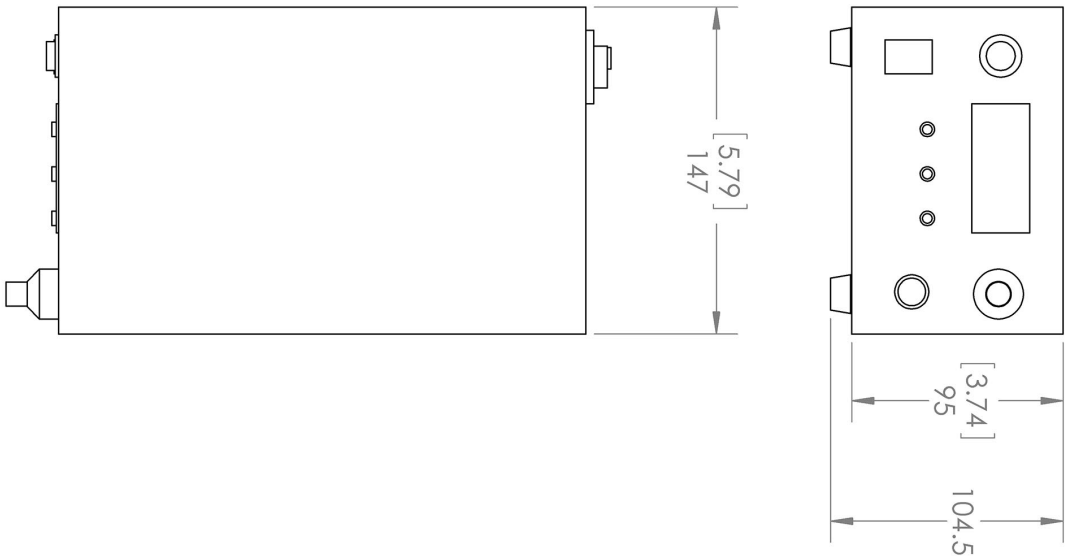







UNLESS OTHERWISE SPECIFIED:
 DIMENSIONS ARE IN MM(INCH)
 TOLERANCES: +/- 0.75 MM

THE INFORMATION CONTAINED IN THIS DRAWING IS THE SOLE PROPERTY OF LASERGLOW TECHNOLOGIES. ANY REPRODUCTION IN PART OR AS A WHOLE WITHOUT THE WRITTEN PERMISSION OF LASERGLOW TECHNOLOGIES IS PROHIBITED. © 2012 LASERGLOW.COM LIMITED. ALL RIGHTS RESERVED

TITLE: Power Supply FH/FF/FN	
SCALE: 1:3	SHEET 1 OF 1
Laserglow Technologies REV 1	

Accessories:

The most popular accessories for model RA6-H are shown below. For additional details regarding these or other accessories please see our website or contact us directly.

Part Number	Description	
 AGFA647XX	LSG-1064-NF-7 Fit-Over Safety Goggles 1064nm Output: OD 7+ at 950-1070 nm CE Certified Full Details: www.arktislaser.com/AGF	
 ACFMIRHXA	FC/PC Fiber Coupler/Collimator for IR wavelengths (1000 to 1300 nm) (installed and aligned) 11mm diameter input lens Full Details: www.arktislaser.com/ACF	
 ACSMIRHXA	SMA-905 Fiber Coupler/Collimator for IR wavelengths (1000 to 1300 nm) (installed and aligned) 11mm diameter input lens Full Details: www.arktislaser.com/ACS	
 AFF2002XX	Armored Fiber With FC/PC Connectors 200um Core Multimode 2m length Full Details: www.arktislaser.com/AFF	
 AFS2002XX	Armored Fiber With SMA 905 Connectors 200um Core Multimode 2 m length Full Details: www.arktislaser.com/AFS	
 TBK	Complete optics kits with breadboard mounting hardware. External modulators, variable attenuators, free-space fiber launch systems Full Details: www.arktislaser.com/TBK	
 ACALBHFXX	Carrying Case-103 Holds Lab/OEM H, F and O size Standard/LabSpec laser Full Details: www.arktislaser.com/ACA	Included With Laser

FOR MORE INFORMATION PLEASE CONTACT:

Arktis Laser
112 Elizabeth St, Unit 5-331, Toronto, ON, Canada M5G 1P5
Tel. 1-416-886-1178 Fax 1-647-874-7129
sales@arktislaser.com www.arktislaser.com

E&OE: Data included in this sheet may be subject to change without notice.
Please confirm critical specifications with our staff prior to ordering.